

CARSON

Carson Manufacturing Co., Inc.
5451 North Rural Street
Indianapolis, IN 46220
Phone: (888) 577-6877 Fax: (317) 254-2667
www.carsonsirens.com

SA-500-20 28 VOLT SIREN AMPLIFIER

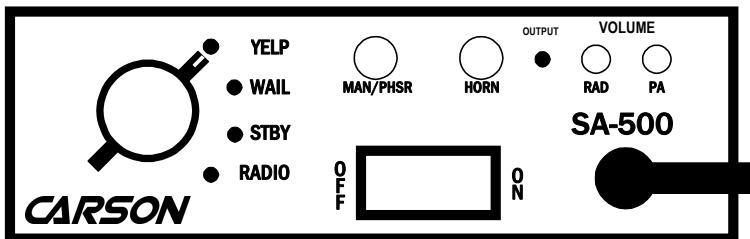

INSTALLATION AND OPERATING INSTRUCTIONS

Carson is a trademark of Carson Manufacturing Company, Inc.

WARNING **Sound Hazard** - Sound level from siren speaker (>120dBA @ 10 feet) may cause hearing damage. Do not operate siren without adequate hearing protection for you and anyone in immediate vicinity. (Ref. OSHA 1910.95 for occupational noise exposure guidelines)



INSTALLATION INFORMATION

MODEL: SA-500- _____	OPTIONS
SERIAL NO: _____	_____ Auxiliary Input Selection
PURCHASE DATE: _____	_____ Two-Tone Selected
DEALER: _____	_____ Phaser Disabled
INSTALL DATE: _____	_____ Horn Disabled
INSTALLER: _____	_____ Yelp Override Selected
_____	_____ Short Manual Selected
_____	_____ HRC2 Selected
_____	_____ Cutout connection/polarity
_____	_____ Auxiliary connection/polarity

Model and serial number located on bottom of unit

TABLE OF CONTENTS

GENERAL DESCRIPTION	3
SPECIFICATIONS	3
INSTALLATION	3
SAFETY PRECAUTIONS	3
UNPACKING	4
MOUNTING	4
OPTION SWITCHES.....	4
ELECTRICAL CONNECTIONS.....	5
OPERATION.....	6
GENERAL	6
SELECTOR SWITCH.....	6
MAN/PHSR	6
HORN.....	6
MICROPHONE.....	6
VOLUME CONTROLS	6
AUXILIARY INPUT	6
CUTOUT	6
HORN RING CYCLER 2 (Optional)	6
SERVICE	7
PROBLEMS	7
PARTS	7
RETURN	8
LIMITED WARRANTY.....	8

NOTICE

Due to continuous product improvements, we must reserve the right to change any specifications and information, contained in this manual at any time without notice.
 Carson Manufacturing Co., Inc. makes no warranty of any kind with regard to this manual, including, but not limited to, the implied warranties of merchantability and fitness for a particular purpose.
 Carson Manufacturing Co., Inc. shall not be liable for errors contained herein or for incidental or consequential damages in connection with the furnishing, performance, or use of this manual.

GENERAL DESCRIPTION

The SA500 Siren Amplifier is a premium unit designed for single or dual 100W speaker use. The primary operating modes are Yelp, Wail, Standby and Radio. A Noise Canceling PA Override and push-button Horn Override are available in all modes except Radio. Another push-button is provided for push-on/push-off Phaser operation in the Yelp and Wail modes, and Manual siren control in the Standby mode. Auxiliary input is provided for connection to horn ring circuit or switch. Latching siren cutout input is provided for connection to a door switch, etc. to stop siren tones when exiting the vehicle. Radio and PA volume controls are provided on the front panel. The front panel is backlit with LED's for night visibility. An internal 8-Position DIP switch allows selection of various options. This compact unit utilizes short circuit, high voltage, and reverse polarity protection systems for maximum service life. Output indicator light on face for diagnostics.

SPECIFICATIONS

Input Voltage	18 - 32 VDC (negative ground)				
Input Current	4 AMPS (@28 VDC - single 100W speaker) 8 AMPS (@28 VDC - dual 100W speakers)				
Standby Current	Less than 100 ma				
Audio Frequency	200Hz - 10 kHz \pm 3db				
Audio Distortion	Less than 7% (@1 kHz - single 100W speaker)				
Audio Output	40 watts (@28 VDC - single 100W speaker)				
Audio Input	400 ohms \pm 10%				
Output Power	105 WATTS RMS MAX. (30 VDC - single 100W speaker) 180 WATTS RMS MAX. (30 VDC - dual 100W speakers)				
Siren Frequency	700Hz - 1500Hz (Two-Tone and Horn = 435 & 585Hz)				
Tones/Cycle Rates	Horn	Wail	Yelp	Phaser	Two-Tone
	109 CPS	13 CPM	190 CPM	15 CPS	60 CPM
High Voltage Protection	32 - 36 VDC will cause siren output to cease, resume at normal				
Short Circuit Current	50 AMPS (supply circuit must be capable of supplying this)				
Operating Temp.	-15° F to +140°F				
Controls	4-position rotary mode switch (Yelp, Wail, Standby and Radio). Momentary push-button Horn switch. Momentary push-button Manual/Phaser toggle switch. Front panel PA and Radio volume controls. Auxiliary input connection programmable for positive or negative activation. Cutout input connection programmable for positive or negative latching operation. Internal 8-Position DIP switch option selector.				
Connections (10-Pin Conn)	(2) Positive, (2) Negative, (2) Speaker, (2) Radio, Cutout, Auxiliary				
Size	6-1/8" Wide, 5-7/8" Deep, 2-1/8" High				
Weight	4-1/2 LBS.				

INSTALLATION

Proper installation of the unit is essential for years of safe, reliable operation. Please read all instruction **before** installing the unit. Failure to follow these instructions can cause serious damage to the unit or vehicle and may void warranties.

SAFETY PRECAUTIONS

For the safety of the installer, vehicle operator, passengers and the community please observe the following safety precautions. **Failure to follow all safety precautions and instructions may result in property damage, injury or death.**

Qualifications - The installer must have a firm knowledge of basic electricity, vehicle electrical systems and emergency equipment.

WARNING  **Sound Hazard** - Sound level from siren speaker (>120dBa @ 10 feet) may cause hearing damage. Do not operate siren without adequate hearing protection for you and anyone in immediate vicinity. (Ref. OSHA 1910.95 for occupational noise exposure guidelines)

Mounting - Mount the unit for easy access by the vehicle operator. DO NOT mount in air bag deployment area. Assure clearances before drilling in vehicle. To prevent internal damage mounting bolts must not enter case more than 1/4".

Wiring - Use wiring capable of handling the current required. Make sure all connections are tight. Route wiring to prevent wear, overheating and interference with air bag deployment. Install and check all wiring before connection to vehicle battery.

Testing - Test all siren functions after installation to assure proper operation. Test vehicle operation to assure no damage to vehicle.

Keep These Instructions - Keep these instructions in the vehicle or other safe place for future reference. Advise the vehicle operator of the location.

UNPACKING

Inspect contents for shipping damage. If found **alert carrier immediately**. Contents should include unit with attached microphone, mounting bracket, microphone bracket with 2 screws, 2 mounting bolts, removable terminal block plug, and these instructions. Contact supplier immediately if any components are missing.

MOUNTING

The mounting bracket supplied can be installed above or below the unit. Choose a mounting location convenient to the operator and away from any air bag deployment areas. Inspect behind mounting area for clearance. Assure adequate ventilation to prevent overheating. Consider wire routing and access to connections, as well as microphone bracket placement. Install mounting bracket to vehicle using 1/4" hardware (not supplied).

If mounting in a rack or console, make sure that mounting bolts do not enter case more than 1/4".

OPTION SWITCHES

Various options can be selected by turning on or off any of 8 DIP switches internally mounted on the right side of the PC board.

Cover Removal - The cover is held in place by a snap-fastener on the back of the unit. Hold the unit with the front case flange on the edge of a hard surface and press hard on the back of the unit. The chassis will slide out the front of the cover.

Cutout Input Polarity - The cutout input is normally activated by connecting to positive. To activate by connecting to negative turn off "CUT_P".

Auxiliary Input Polarity - The auxiliary input is normally activated by connecting to positive. To activate by connecting to negative turn off "AUX_P".

Auxiliary Input Function - The auxiliary input normally activates the Horn function. To activate the Man/Phsr function with the auxiliary input turn on "AUX_I".

Two-Tone - Two-Tone can replace Phaser by turning on "T-T".

Phaser Disable - The Phaser function can be completely disabled by turning on "P_I".

Note: when Phaser is disabled the Man/Phsr pushbutton will toggle between Wail and Yelp.

Horn Disable - The Horn function can be completely disabled by turning on "H_I".

Yelp Override - Causes the Man/Phsr function to toggle to Yelp with selector switch in Wail mode. Turn on "YLP_O".

Short Manual - The Manual function can be set to immediately cut off when the Man/Phsr pushbutton is released. Turn on "SM".

Horn Ring Cyclor 2 (HRC2) - Turn on "T-T" and "P_I" to enable this feature. Also connect the auxiliary input to the horn ring or other switch. While the siren is in standby, tap the horn ring to bring the unit out of standby into Wail tone. Repeatedly tapping the horn ring will cycle through Wail, Yelp, and Phaser tones. Tapping the horn ring twice quickly will stop the siren tones and return the unit to standby. Pressing and holding the horn ring will produce Horn tone until released. Then the siren will return to its previous siren tone or standby.

NOTE: Earlier models with S/N lower than 04190000 have a different version of **HRC**. In this case the siren tones cycle through Standby, Wail, Yelp, and Phaser. The tone is stopped by cycling to Standby.

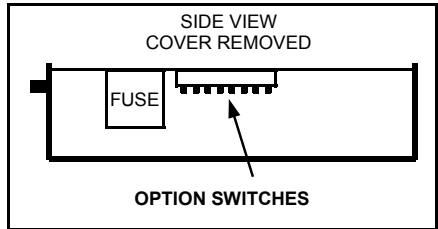

ELECTRICAL CONNECTIONS

Electrical connections to the unit are made using a removable terminal block plug located on the back. A label on the unit identifies the terminal function. You should install the plug on the unit before wiring. If the unit needs service the plug can be easily removed without unwiring.

The power supply of the unit must be capable of delivering peak currents up to 50 amps for adequate short circuit protection and reliable operation. The preferred source is directly at the vehicle battery. The unit is internally fused.

Attach leads by stripping 3/8", inserting into plug and clamp by tightening screw. Make sure the screw is tight and the wire can't be pulled out. Failure to adequately tighten the screw can result in improper operation or burning the connector and wire.

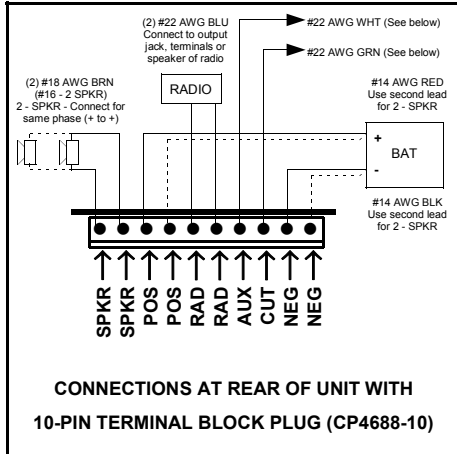

Wire Size and Termination - The diagram shows the minimum wire size used for each connection, along with recommended lead color. If the wire is longer than 10 ft. use the next larger wire size. Use only high quality crimp connectors for installation on the vehicle.

Auxiliary Input Connection

The Auxiliary Input allows activation by an external source of either the Horn or Man/Phsr function. The adjacent diagram shows three connection examples. See OPTION SWITCHES section for programming details. NOTE: Permanent disconnection of the vehicle horn is NOT recommended.

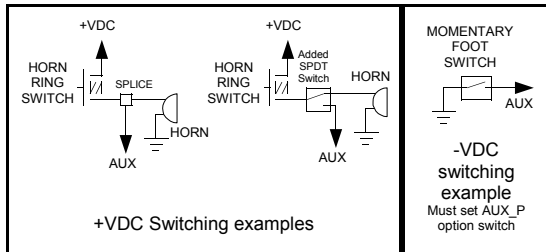

Cutout Input Connection - The Cutout Input turns off any siren tone output when activated, and remains off until a control is activated or changed. The adjacent diagram shows two connection examples. See OPTION SWITCHES section for programming details.

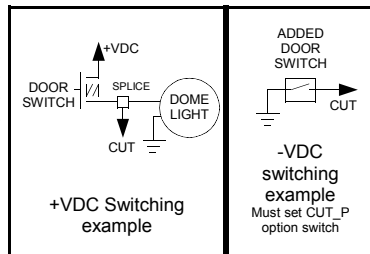

OPERATION

WARNING Sound Hazard - Sound level from siren speaker (>120dBA @ 10 feet) may cause hearing damage. Do not operate siren without adequate hearing protection for you and anyone in immediate vicinity. (Ref. OSHA 1910.95 for occupational noise exposure guidelines)

GENERAL

This unit is designed for easy operation under the stress associated with high-speed pursuit. Most siren functions are accessible with one simple motion without repetitive activation of switches or automatic timed switching that can interfere with desired operation.

SELECTOR SWITCH

The rotary selector switch controls the primary operating mode of the siren.

Yelp - A rapidly changing tone used in congested areas.

Wail - A slower changing tone used on highways.

Stby - A silent mode that allows Manual, Horn and Public Address operation.

Radio - Also known as Radio Repeat, this mode amplifies a radio speaker input for re-broadcast outside the vehicle. No siren tones or PA operation are available in this mode.



MAN/PHSR

This momentary push-button switch provides a very rapid changing tone (Phaser) when the selector switch is in the Yelp or Wail positions. This tone is used at intersections and very highly congested areas. Pressing the button once changes to the Phaser tone and pressing again changes the tone back to Yelp or Wail.

With the selector switch in the Stby position this switch provides Manual siren tone control, rising when pressed and falling when released. This is used to momentarily alert motorists or in low noise areas.

Phaser may be replaced by **Two-Tone** or disabled. See OPTION SWITCHES section.



HORN

This momentary push-button switch provides a simulated air-horn tone while pressed. This can be used to supplement the normal vehicle horn and is useful at intersections or in low noise areas. This tone overrides other siren tones. Horn may be disabled. See OPTION SWITCHES section.

MICROPHONE

The attached noise-canceling microphone is used for public address operation and overrides any siren tone when the button on the side (PTT) is pressed.

VOLUME CONTROLS

Controls are provided for radio repeat volume and public address volume. These should be set when the vehicle is parked. Set the RAD volume with the selector switch in the Radio position and the radio volume set to desired level. Set the PA volume to the maximum level with no feedback (squeal).

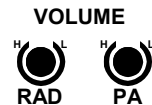

AUXILIARY INPUT

During installation an auxiliary input may be connected to the horn ring or other switching device. It provides the same operation as pressing the Horn button or optionally the Man/Phsr button.

CUTOUT

During installation, a cutout input may be connected to a door switch. It turns off any siren tone when the door is opened. The siren tone will continue to be cut off even when the door is closed. Changing any switch or input will restore normal function.

HORN RING CYCLER 2 (Optional)

Available while selector switch is in standby, repeatedly tapping the horn ring or other switch will cycle through Wail, Yelp, and Phaser tones. Tapping the horn ring twice quickly will stop siren tones. Holding the horn ring produces horn. See OPTION SWITCHES section for further details.

SERVICE

This unit is designed to provide years of reliable service under even the worst conditions. Many times there may appear to be a problem with the unit when the true problem is in the speaker(s) or improper installation. The following chart shows typical symptoms and possible causes.

A blown internal fuse doesn't necessarily mean that the unit is bad. If a speaker or speaker lead is shorted the internal fuse will blow before the unit is damaged. Disconnect the SPKR leads and replace the fuse. If the **OUTPUT** light comes on (dim lighting to see) with power on and Yelp selected it is OK. Check the speaker(s) or leads for possible shorting.

PROBLEMS

Symptom	Possible Cause	Check
No power or siren output	Power switch not turned on Bad speaker(s) Connector loose Internal fuse blown Loose connection at power source	Does backlighting come on? Do you hear a "pop" when turned on? Is the OUTPUT light on front panel coming on in Yelp? Is an external fuse or circuit breaker used? Are the negative leads connected to a good ground?
No siren tone - PA works	High Voltage Protection Mic button stuck Cutout activated Cutout Polarity Option set wrong	Input voltage must be less than highest rated voltage. Does mic button release properly? Does the siren work when Cutout input is disconnected? Is the CUT_P option properly configured?
No PA	PA volume not set properly Selector in Radio position	Have you tried turning the PA volume control? PA is not available in the Radio position
Distorted siren sound	Speaker assembly loose Intermittent Aux Input connection Low vehicle voltage	Is the speaker bell or tip loose? Is the Auxiliary Input used and wired properly? Input voltage must be greater than lowest rated voltage.
Intermittent siren tone	High Voltage Protection Connector loose Bad power connection Mic button activation Circuit breaker in supply connection	Is the vehicle voltage regulator working properly? Is the connector tight on the back of the unit? Is there a loose connection on a power lead? Is something lying on the microphone? Is a circuit breaker used with at least a 50A rating?
Horn function or Manual or Phaser stuck on	Horn switch stuck Man/Phsr switch stuck Aux Input improperly connected Aux Input Polarity Option set wrong	Does the horn switch return fully when released? Does the Man/Phsr switch return fully when released? Is the Aux Input used and wired properly? Is the AUX_P option properly configured?
No Radio	Unit not connected to radio Radio volume too low	Is the radio connected properly to the unit? Can you here the radio in the vehicle? Have you tried turning the RAD volume control?
Wrong siren tone	Two-Tone option installed Aux Input set to wrong function Yelp Override option installed	Is the T-T option selected? Is the AUX_I option configured properly? Is the YLP_O option selected?
Phaser not working	Phaser disabled	Is the P_I option selected?
Horn not working	Horn disabled	Is the H_I option selected?

PARTS

The following parts are available from Carson Manufacturing Company, Inc.:

Part	Description
CP3966	Bolt, mounting, 1/4-20 X 3/8" (2 required)
CP3571	Bracket, mounting
CP4688-10	Connector, 10-pin Terminal Block Plug
CP4680-1	Cover (not including chassis)
ATO/ATC 10A	Fuse, 10 Amp Automotive
CP4852	Knob, selector switch
CP4750	Microphone, Noise Canceling w/Connector
CP3633	Microphone Bracket with mounting Screws
SR-15-1	Microphone Strain Relief
CP4119	Transistor, output (2 required) (Industry standard TIP36C, Not Texas Instruments)
ED1558	Hardware Kit (Connector, bolts, microphone bracket with screws)
CP4930	Instruction Manual

RETURN

If you have any questions concerning this or any other Carson product, please contact our **Technical Service Department** at (888) 577-6877. Many issues can be handled over the phone. We can also be reached via e-mail at **service@carsonsirens.com**

If a product must be returned for any reason, please contact our Technical Service Department to obtain a Returned Merchandise Authorization number (RMA#) before you ship the product to Carson. Please write the RMA# clearly on the package near the mailing label. Be sure to provide a return address, contact and phone number, along with a brief description of the problem.

LIMITED WARRANTY

Carson Manufacturing Company, Inc. warrants this new product to be free from defects in material and workmanship, under normal use and service, for a period of five (5) years from the date of delivery to the first user-purchaser.

During this warranty period the obligation of Carson Manufacturing is limited to repairing or replacing, as Carson Manufacturing may elect, any part or parts of such product which after examination by Carson Manufacturing is determined to be defective in material and/or workmanship.

This warranty does not cover labor charges for removal or re-installation of the product. Fuses and lamps are not covered under this warranty.

This warranty does not extend to any unit that has been subjected to abuse, misuse, improper installation or which has not been adequately maintained, nor to units which have problems related to service or modification at any facility other than the manufacturer.

THERE ARE NO OTHER WARRANTIES, EXPRESSED OR IMPLIED, INCLUDING BUT NOT LIMITED TO, ANY IMPLIED WARRANTIES OF MERCHANTABILITY OR FITNESS FOR A PARTICULAR PURPOSE. IN NO EVENT SHALL CARSON MANUFACTURING COMPANY, INC. BE LIABLE FOR ANY LOSS OF PROFITS OR ANY INDIRECT OR CONSEQUENTIAL DAMAGES ARISING OUT OF ANY SUCH DEFECT IN MATERIALS OR WORKMANSHIP.