

CARSON MANUFACTURING CO., INC.  
5451 NORTH RURAL STREET  
INDIANAPOLIS, IN 46220  
(888) 577 6877 [www.carsonsirens.com](http://www.carsonsirens.com)

## TECHNICAL BULLETIN

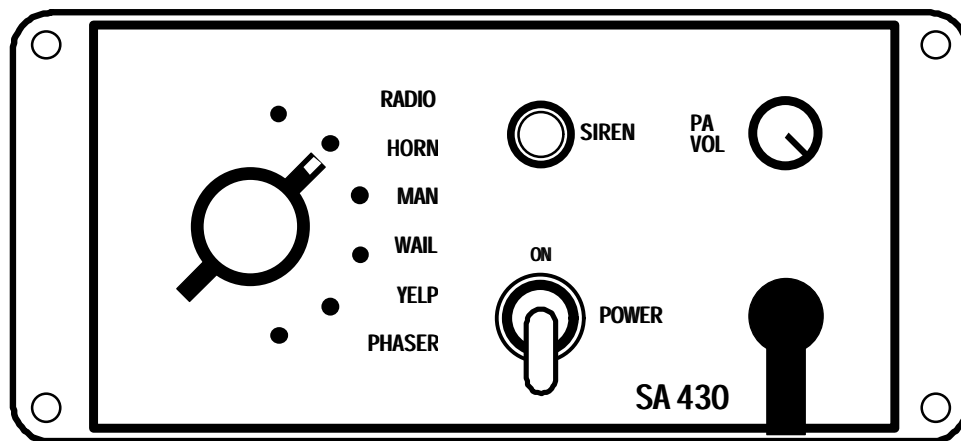

## INSTALLATION AND OPERATING MANUAL

SA-430-73F (FLUSH MOUNT CONTROL HEAD)  
SA-430-73FX (FLUSH MOUNT WITH EXTENDED MIC)  
SA-430-73V (FLUSH MOUNT WITH VERTICAL LABEL)

### WARNING



**Sound Hazard** - Sound level from siren speaker (>120dBA @ 10 feet) may cause hearing damage. Do not operate siren without adequate hearing protection for you and anyone in immediate vicinity. (Ref. OSHA 1910.95 for occupational noise exposure guidelines)

## SA-430-73 SPECIFICATIONS

<b>INPUT POWER:</b>	11-16 Volts DC, 8 Amps DC per 100W Speaker Power off current to amplifier is 25mA Max.
<b>SIREN MODE</b>	
<b>OUTPUT POWER:</b>	15 VDC input, 100W speaker(s) One speaker - 105 Watts RMS Two speakers - 180 Watts RMS Rating not available for 58W or 80W speakers
<b>AUDIO MODE</b>	
<b>OUTPUT POWER:</b>	14 VDC input, 100W speaker(s) One speaker - 40 Watts RMS Two speakers - 80 Watts RMS Rating not available for 58W or 80W speakers
<b>SIREN</b>	
<b>FREQUENCY:</b>	600Hz - 1350Hz Nominal
<b>CYCLE RATES:</b>	WAIL - 14 cycles/min YELP - 190 cycles/min PHASER - 15 cycle/sec
<b>AUDIO</b>	
<b>RESPONSE:</b>	200Hz - 10KHz +/-3db Harmonic Distortion Less than 3% @ 1KHz
<b>RADIO INPUT</b>	
<b>SENSITIVITY:</b>	0.75VAC Input Min. for 40 Watts RMS Output (1 spkr)
<b>OPERATING</b>	
<b>TEMPERATURE:</b>	-15° F to +140° F
<b>SIZE:</b>	Amplifier 8-7/8" Wide X 1-13/16" High X 5-1/2" Deep Control Head 6-1/4" Wide X 2-7/8" High X 1" Deep
<b>WEIGHT:</b>	Amplifier 2.5 pounds Control Head 1 pound
<b>NIGHT VISIBILITY:</b>	Control Head panel is backlit with independent lead tied to vehicle dash lights.
<b>AMPLIFIER PROTECTION:</b>	High Voltage – Siren output stops with input voltage above highest rating Stops high output power from blowing speaker Reverse Polarity - Fuse blows when power is wired backwards Shorted Output – Fuse blows if speaker shorts (a common problem)
<b>CONTROL HEAD PROTECTION:</b>	No fuse but has reverse polarity protection.

### NOTICE

Due to continuous product improvements, we must reserve the right to change any specifications and information, contained in this manual at any time without notice.

Carson Manufacturing Co., Inc. makes no warranty of any kind with regard to this manual, including, but not limited to, the implied warranties of merchantability and fitness for a particular purpose.

Carson Manufacturing Co., Inc. shall not be liable for errors contained herein or for incidental or consequential damages in connection with the furnishing, performance, or use of this manual.

## INSTALLATION

Proper installation of the unit is essential for years of safe, reliable operation. Please read all instruction **before** installing the unit. Failure to follow these instructions can cause serious damage to the unit or vehicle and may void warranties.

### SAFETY PRECAUTIONS

For the safety of the installer, vehicle operator, passengers and the community please observe the following safety precautions. **Failure to follow all safety precautions and instructions may result in property damage, injury or death.**

**Qualifications** - The installer must have a firm knowledge of basic electricity, vehicle electrical systems and emergency equipment.

#### WARNING



**Sound Hazard** - Sound level from siren speaker (>120dBA @ 10 feet) may cause hearing damage. Do not operate siren without adequate hearing protection for you and anyone in immediate vicinity. (Ref. OSHA 1910.95 for occupational noise exposure guidelines)

**Mounting** - Mount the control head for easy access by the vehicle operator. DO NOT mount in air bag deployment area. Assure clearances before drilling in vehicle.

**Wiring** - Use wiring capable of handling the current required. Make sure all connections are tight. Route wiring to prevent wear, overheating and interference with air bag deployment. Install and check all wiring before connection to vehicle battery.

**Testing** - Test all siren functions after installation to assure proper operation. Test vehicle operation to assure no damage to vehicle.

**Keep These Instructions** - Keep these instructions in the vehicle or other safe place for future reference. Advise the vehicle operator of the location.

### AMPLIFIER MOUNTING

Choose a mounting location in an area such as the driver compartment firewall, under a seat, etc. Mounting the amplifier in the engine compartment or in an area directly exposed to weather is not recommended. Assure adequate ventilation to prevent overheating. Consider wire routing and access to connector. Install amplifier to vehicle using 1/4" hardware (not supplied).

May need to set RADIO VOLUME ADJUST on side of amplifier before final mounting and installation.

May also need to set POWER OUTPUT ADJUSTMENT on inside of amplifier.

### CONTROL HEAD MOUNTING

Select a mounting location in an area such as the dash or overhead console. Choose a mounting location convenient to the operator and away from any air bag deployment areas. Consider wire routing and access to connections, as well as microphone bracket placement.

A microphone clip along with mounting screws (CP3633) holds the microphone in place.

### FLUSH MOUNT

The flush mount control head requires a hole in the dash. Use the mounting template on the last page. Note that the template may not print actual size and may need sizing on a copier. Use #6 screws to fasten to dash.

### FLUSH MOUNT WITH EXTENDED MICROPHONE

The flush mount control head with extended microphone is mounted the same as the flush mount except that the microphone cable extension will also go behind the dash. Allow room for this cable as well.

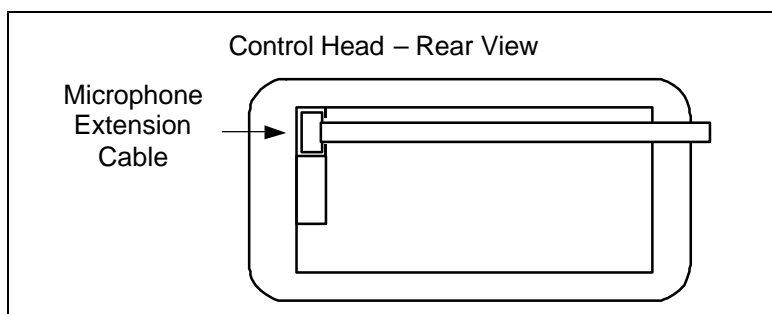

## CONTROL HEAD ELECTRICAL CONNECTIONS

All control head leads may be extended with #22 AWG or larger lead wire.

**Negative Connection (Black)** - Connect to same ground or negative supply as amplifier.

**Positive Connection (Red)** - Connect to positive DC supply. It is recommended that the lead be connected to the accessory output of the fuse block. This provides additional protection of a fused input to the control head.

**Lights (Yellow)** - This lead may be connected to the dash lights or to the red power lead. Connecting to the dash lights will turn on the panel lights whenever the dash lights are on.

When connected to the red lead, make sure that the ignition switch controls the power to that connection. This prevents the panel lights from being continuously on.

**Control (White)** - Connect to white lead from amplifier. Route this lead away from radio transmitter antenna lead to prevent RF interference being fed to the siren amplifier.

**Auxiliary Input (Green)** - Used for Siren control. Performs same function as Siren button. Connect to a normally open switch or to horn ring circuit. Circuit may connect to either positive or negative. When connected to horn ring circuit, use a SPDT switch to connect horn ring to either vehicle horn or to manual control circuit.

NOTE: Permanent disconnection of the vehicle horn is NOT recommended.

NOTE: Be sure to cut lead short if not used to prevent R.F. interference and insulate with electrical tape.

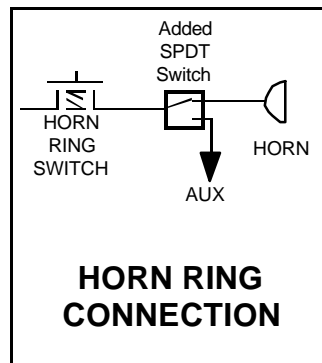

## AMPLIFIER ELECTRICAL CONNECTIONS

### Disconnect vehicle battery before making the following electrical connections.

Electrical connections to the amplifier are made using the wiring harness supplied. If the amplifier needs service the connector can be easily removed without unwiring the harness. The power supply for the amplifier must be capable of delivering peak currents up to 50 amps for adequate short circuit protection and reliable operation. The preferred source is directly at the vehicle battery. A fuse on the unit protects from overload.

**Wire Size and Termination** - The diagram shows the minimum wire size used for each connection. If the wire is longer than 10 ft. use the next larger wire size. Use only high quality crimp connectors for installation on the vehicle.

**Negative Connection (Black)** - Both leads must be used. Connect to negative battery connector or high current buss.

**Positive Connection (Red)** - Both leads must be used. Connect to positive battery connector or high current buss. A power relay may be used.

**Speaker Connection (Brown)** - Both leads must be used. Connect 1 lead to each terminal or lead of the speaker. When used with 2 speakers connect each brown lead to both speaker terminals or leads (parallel circuit). Observe polarity (phasing) when connecting 2 speakers.

**Control Connection (White)** - Connect to white lead from control head. Route this lead away from radio transmitter antenna lead to prevent RF interference being fed to the siren amplifier.

**Optional Radio Input Connection (Blue)** - Connect 1 lead to each terminal of the radio speaker or output connector. The input is isolated and polarity is not important. May need to set RADIO VOLUME ADJUST on side of unit.

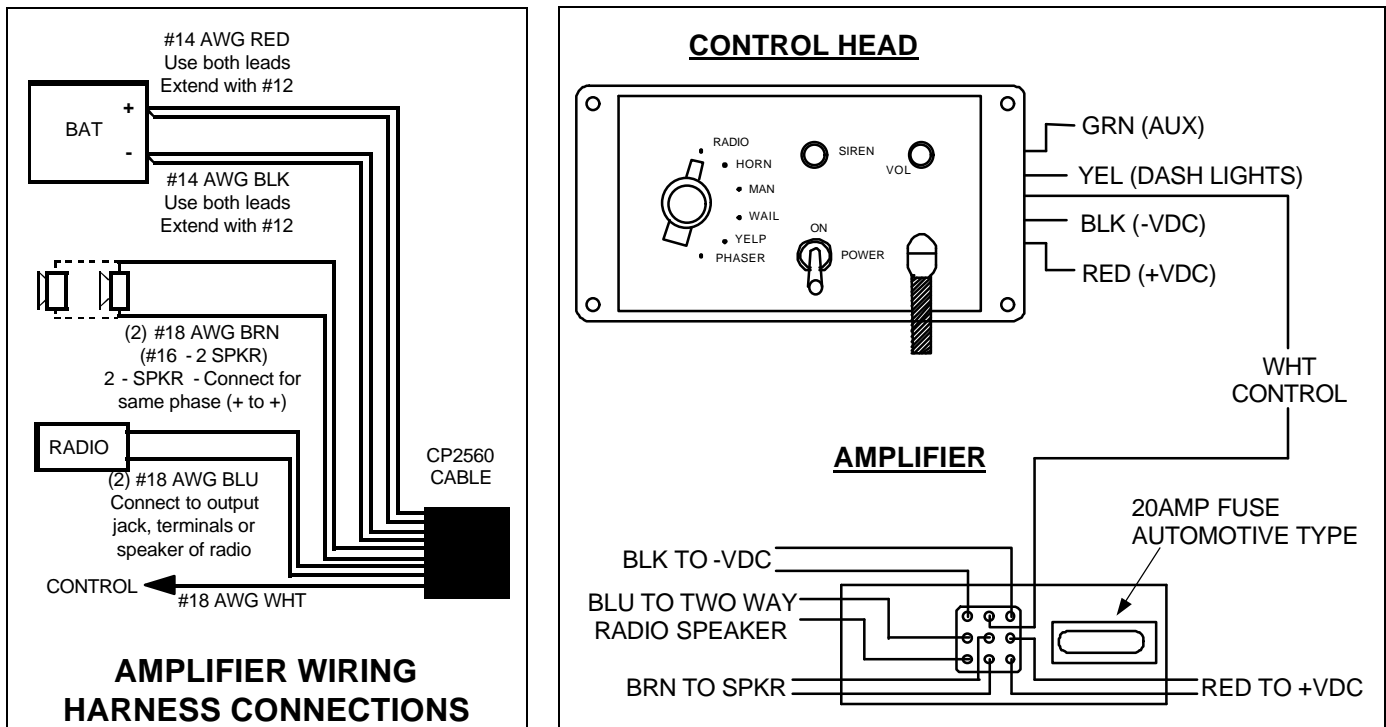

## OPERATION

### WARNING



**Sound Hazard** - Sound level from siren speaker (>120dBA @ 10 feet) may cause hearing damage. Do not operate siren without adequate hearing protection for you and anyone in immediate vicinity. (Ref. OSHA 1910.95 for occupational noise exposure guidelines)

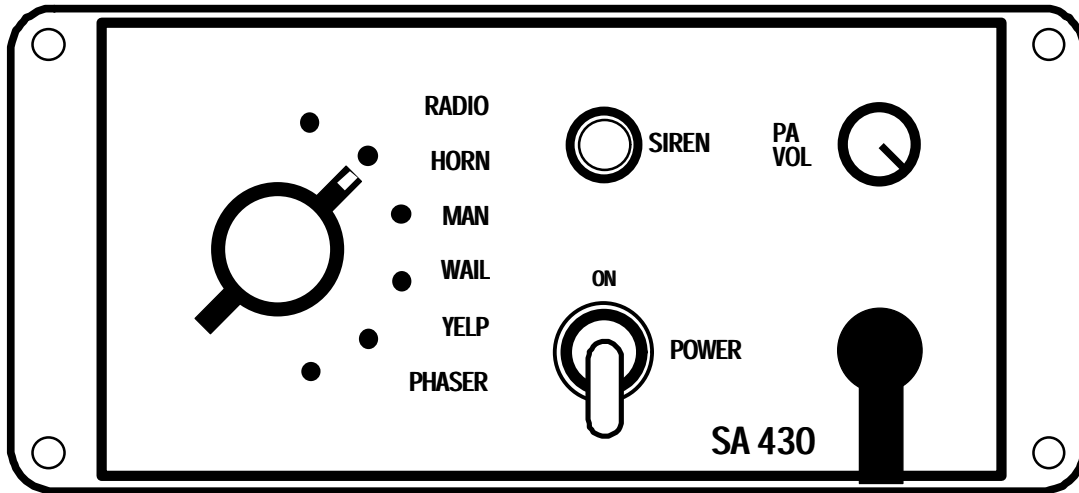

The Toggle Power Switch controls the siren power. The siren may be left on any time the vehicle is in operation. The power should be turned off when vehicle is not being used to conserve battery power.

The Rotary Function Switch selects various operating modes. These modes are as follows:

- RADIO -** This mode reproduces, or repeats, the output of a radio. The radio must be connected and RADIO VOLUME ADJUSTed for this mode to function. PA override available in this mode.
- HORN -** Also considered a standby mode. Horn and PA Override available in this mode.
- MAN -** The siren tone is controlled Manually with SIREN button. PA Override available in this mode.
- WAIL -** The siren produces a normal rise-fall tone pattern. This mode should be used on highways or areas with constant traffic flow. Yelp and PA Override available in this mode.
- YELP -** The siren produces a moderate warble tone. This mode should be used in lightly congested areas. Horn and PA Override available in this mode.
- PHASER -** The siren produces a very fast warble tone. This mode should be used at intersections or in highly congested areas. Horn and PA Override available in this mode.

### OVERRIDE FUNCTIONS

#### **PUBLIC ADDRESS (PA) OVERRIDE -**

Pressing the microphone button in any operating mode allows the operator to use the siren as a public address amplifier. The operating mode resumes when the button is released. (Hold the microphone close to your lips for proper operation and adjust the PA VOLUME Control)

#### **HORN OVERRIDE -**

By pressing the SIREN button the siren tone output is replaced by the horn tone. The siren tone resumes when the button is released. (This feature is not available in WAIL mode.)

#### **YELP OVERRIDE -**

Available only in WAIL mode. By momentarily pressing the SIREN button the tone output is switched to the Yelp tone. Pressing the button again switches the tone output back to Wail.

## RADIO VOLUME ADJUST

The RADIO VOLUME ADJUST is a one time setting which depends on the radio connected and its normal volume.

Access the RADIO VOLUME ADJUST through a hole on the side of the amplifier.

Switch siren to RADIO mode and turn on the power. With the volume on the radio itself set to normal level, set the RADIO VOLUME ADJUST to the desired level.

## POWER OUTPUT ADJUST

The POWER OUTPUT ADJUSTMENT is a one time setting which depends on the speaker(s) used.

The amplifier cover must be removed to access the adjustment.  
Remove the 4 screws on the side of the amplifier.

For 58W or 80W speaker(s), set the POWER OUTPUT SWITCH to "58/80".  
For 100W speaker(s) set the POWER OUTPUT SWITCH to "100".

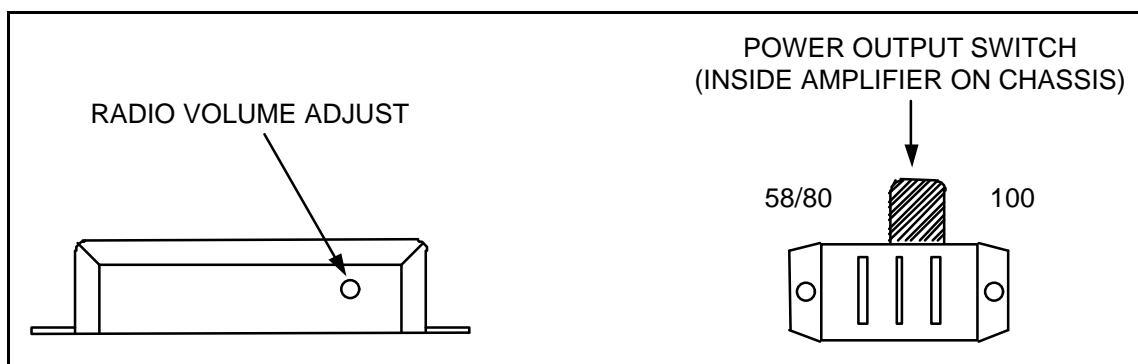

## SERVICE

This unit is designed to provide years of reliable service under even the worst conditions. Many times there may appear to be a problem with the unit when the true problem is in the speaker(s) or improper installation. The following chart shows typical symptoms and possible causes.

A blown fuse doesn't necessarily mean that the unit is bad. If a speaker or speaker lead is shorted this fuse will blow before the unit is damaged. Disconnect the SPKR leads and replace the fuse. If the siren emits a sound when in the Yelp position it is OK. Check the speaker(s) or leads for possible shorting.

### PROBLEMS

Symptom	Possible Cause	Check
No Power or siren output	Power switch not turned on Bad Speaker Connector or connections loose Fuse blown Loose connection at power source	Does backlighting come on? Do you hear a "pop" when turned on? With siren on, yelp selected, listen for tone in amplifier. Is an external fuse or circuit breaker used? Are the power leads connected to a good buss?
No siren tone – PA works	High Voltage Protection Mic Button stuck	The input voltage must be less than highest rating. Does Mic Button release properly?
No PA	PA volume not set properly	Try turning the PA volume control.
Distorted siren sound	Speaker assembly loose Intermittent Aux Input connection Low Vehicle voltage	Is the speaker bell or tip loose? Is the Aux Input used and wired properly? The input voltage must be greater than lowest rating.
Intermittent siren tone	High Voltage Protection Connector loose Loose connection at power source Mic Button activation Circuit breaker in supply connection	Is the vehicle voltage regulator working properly? Is the connector tight on the back of the unit? Check for loose leads back to power source. Is something lying on the microphone? Is a circuit breaker used with at least 50A rating?
Horn or manual stuck on	Siren switch stuck Aux Input improperly connected	Does the Siren pushbutton switch return fully when released? Is the Aux Input used and wired properly?
No Radio	Unit not connected to a radio Radio volume too low	Is the radio connected properly to the unit? Can you hear the radio in the vehicle? Try adjusting the internal radio volume control.
Wrong siren tone	Ground system noise	Are control head and amplifier connected to good ground?

## RETURN

If you have any questions concerning this or any other Carson product, please contact our **Technical Service Department** at (888) 577-6877. Many issues can be handled over the phone. We can also be reached via e-mail at [service@carsonsirens.com](mailto:service@carsonsirens.com)

If a product must be returned for any reason, please contact our Technical Service Department to obtain a Returned Merchandise Authorization number (RMA#) before you ship the product to Carson. Please write the RMA# clearly on the package near the mailing label. Be sure to provide a return address, contact and phone number, along with a brief description of the problem.



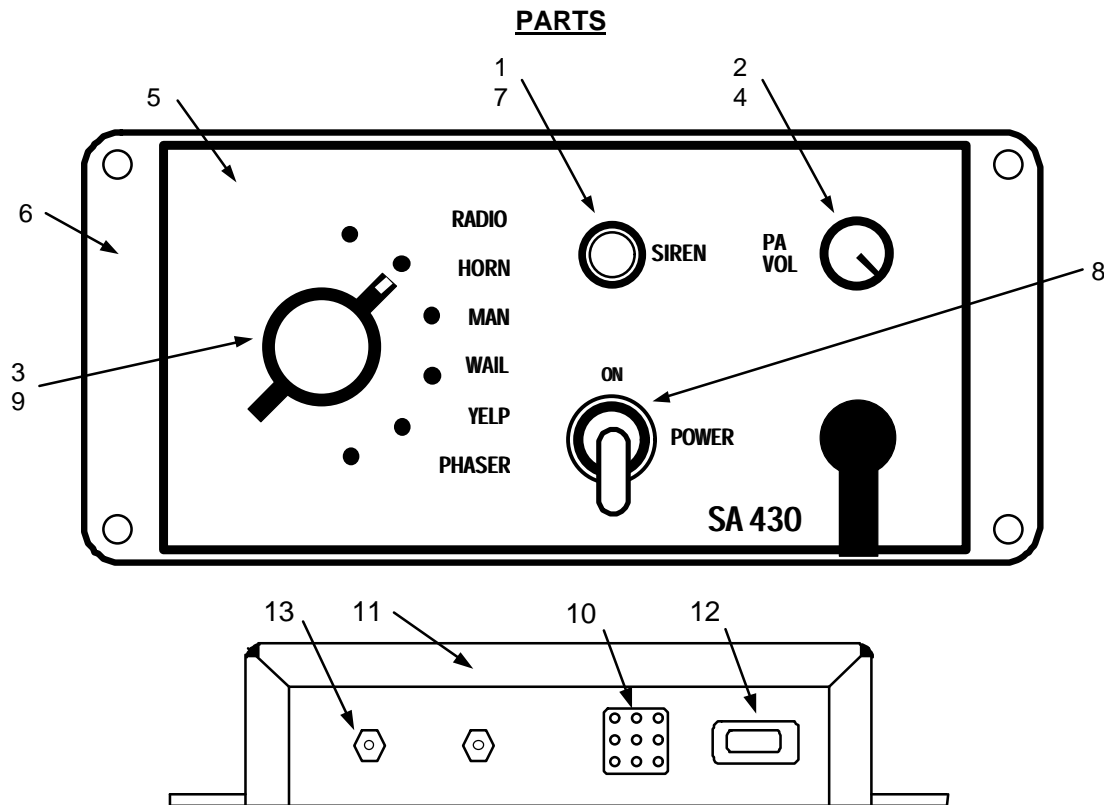

### Control Head

Item	Part #	Description
1	8025 DRS/CAP	Button, red w/ dress nut (C&K #801803000 Cap, #702501201 Nut) (for pushbutton switch)
	CP3040	Cable, control head power
	ES00003-09	Cable, microphone extension 8FT (CP3850 is 18FT) (for SA-430-73FX version)
2	CP3046	Control, PA volume (1K ohm) (for all other PCB's)
	CP4000	Control, PA volume no face mount (1K ohm) (for PCB CP3873 Rev. E and higher)
	CP3045	Cover, control head back (for PCB CP2602)
	CP3880	Cover, control head back push on (for PCB CP3873)
3	CP4852	Knob, rotary function switch
4	CP4853	Knob, PA volume control
5	CP3149	Label, control head front panel (for SA-430-73F and FX version)
	CP3853	Label, control head front panel vertical (for SA-430-73V version)
	JKL#7001PSBL	Lamp, T-1-3/4 14V Bi-pin (JKL #7001)
	CP3570	Microphone (for SA-430-73F and V version)
	ES00028-10	Microphone with locking connector (for SA-430-73FX version)
	CP3633	Microphone clip with mounting screws
6	CP3035-1	Panel, control head front
	SR3055	Rivet, plastic snap for back cover (Richco #SR-3055B)
7	8121D2V40	Switch, pushbutton siren (C&K #8121SD2V4GE)
8	7101-T-C-Q	Switch, toggle power (C&K #7101TCQ)
9	CP3599	Switch, rotary function

### Amplifier

Item	Part #	Description
10	CP3866	Cable, amplifier internal chassis plug wiring harness
	CP2560	Cable, amplifier external wiring harness
11	CP3606	Cover, amplifier (does not include CP3605 chassis)
12	CP3408	Fuse holder
	SR3055	Rivet, plastic snap for PCB mount (Richco #SR-3055B)
13	CP4119	Transistor, output (2 required) (Industry standard TIP36C, Not Texas Instruments)

# CONTROL HEAD INSTALLATION TEMPLATE

