

CARSON

Carson Manufacturing Co., Inc.
5451 North Rural Street
Indianapolis, IN 46220
Phone: (888) 577-6877 Fax: (317) 254-2667
www.carsonsirens.com

SA-400-11 HORN ONLY SIREN AMPLIFIER

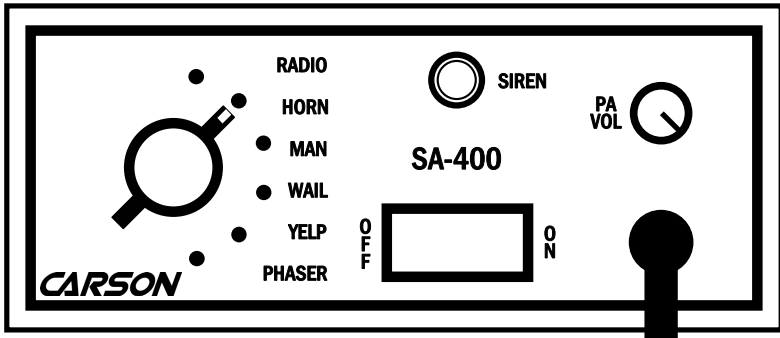

INSTALLATION AND OPERATING INSTRUCTIONS

Carson is a trademark of Carson Manufacturing Company, Inc.

WARNING Sound Hazard - Sound level from siren speaker (>120dBA @ 10 feet) may cause hearing damage. Do not operate siren without adequate hearing protection for you and anyone in immediate vicinity. (Ref. OSHA 1910.95 for occupational noise exposure guidelines)

TABLE OF CONTENTS

GENERAL DESCRIPTION	3
SPECIFICATIONS	3
INSTALLATION	4
SAFETY PRECAUTIONS	4
UNPACKING	4
OPTION SWITCHES	5
MOUNTING	6
ELECTRICAL CONNECTIONS	6
OPERATION	8
GENERAL	8
SELECTOR SWITCH	8
MICROPHONE	8
PA VOL	8
SIREN SWITCH	9
AUXILIARY INPUT	9
RADIO VOLUME	9
SERVICE	10
PROBLEMS	10
PARTS and ACCESSORIES	11
RETURN	12
WARRANTY	12

NOTICE

Due to continuous product improvements, we must reserve the right to change any specifications and information, contained in this manual at any time without notice.

Carson Manufacturing Co., Inc. makes no warranty of any kind with regard to this manual, including, but not limited to, the implied warranties of merchantability and fitness for a particular purpose.

Carson Manufacturing Co., Inc. shall not be liable for errors contained herein or for incidental or consequential damages in connection with the furnishing, performance, or use of this manual.

See www.carsonsirens.com for latest information.

GENERAL DESCRIPTION

The SA-400 Siren Amplifier is a premium unit designed for single or dual 100W speaker use. A 6-position rotary selector switch controls the primary operating modes for Horn and Radio. A Siren push-button switch provides immediate Horn tone override in all modes except Radio. An independent rocker switch controls power. A permanently mounted noise canceling PA microphone with front panel volume control overrides all modes except Radio. An internal control is used to adjust Radio volume. An auxiliary input is provided for connection to a positive or negative horn ring circuit or switch, performing the same function as the Siren push-button. Internal DIP switches allow Auxiliary Input Polarity selection and Horn disable. The front panel is backlit with LED's for night visibility. This durable unit utilizes short circuit, high voltage, and reverse polarity protection systems for maximum service life over a wide temperature range.

SPECIFICATIONS

Input Voltage	9 - 16 VDC (negative ground)
Input Current	8 AMPS (@14 VDC - single 100W speaker) 16 AMPS (@14 VDC - dual 100W speakers)
Standby Current	Less than 150 mA
Audio Frequency	200Hz - 10 kHz \pm 3db
Audio Distortion	Less than 3% (@1 kHz - single 100W speaker)
Audio Output	40 watts (@14 VDC - single 100W speaker)
Audio Input	0.75V RMS MIN. 400 ohms \pm 10%
Output Power	105 WATTS RMS MAX. (15 VDC - single 100W speaker) 180 WATTS RMS MAX. (15 VDC - dual 100W speakers)
Siren Frequency	Horn = 435 & 585 Hz
Tones / Cycle Rates	Horn 109 CPS
High Voltage Protection	16 - 18 VDC will cause siren output to cease, resume at normal
Short Circuit Current	50 AMPS (supply circuit must be capable of supplying this for 1 second)
Operating Temperature	-15° F to +140°F
Controls	6-position rotary mode switch (Radio, Manual Horn, Manual Horn, Horn Cycle 1, Horn Cycle 2, and Horn Cycle 3) Momentary push-button Siren switch. Front panel mounted PA volume control, internal Radio adjust Auxiliary input for positive or negative connection. Internal DIP switch option selector.
Connections (9-Pin Conn)	(2) Positive, (2) Negative, (2) Speaker, (2) Radio, Auxiliary
Size	6-1/8" Wide, 5-3/8" Deep, 2-1/2" High
Weight	5-1/2 LBS.

INSTALLATION

Proper installation of the unit is essential for years of safe, reliable operation. Please read all instruction **before** installing the unit. Failure to follow these instructions can cause serious damage to the unit or vehicle and may void warranties.

SAFETY PRECAUTIONS

For the safety of the installer, vehicle operator, passengers and the community please observe the following safety precautions. **Failure to follow all safety precautions and instructions may result in property damage, injury or death.**

Qualifications - The installer must have a firm knowledge of basic electricity, vehicle electrical systems and emergency equipment.

WARNING  **Sound Hazard** - Sound level from siren speaker (>120dBA @ 10 feet) may cause hearing damage. Do not operate siren without adequate hearing protection for you and anyone in immediate vicinity. (Ref. OSHA 1910.95 for occupational noise exposure guidelines)

Mounting - Mount the unit for easy access by the vehicle operator. DO NOT mount in air bag deployment area. Assure clearances before drilling in vehicle. To prevent internal damage mounting bolts must not enter case more than 1/4".

Wiring - Use wiring capable of handling the current required. Make sure all connections are tight. Route wiring to prevent wear, overheating and interference with air bag deployment. Install and check all wiring before connection to vehicle battery.

Testing - Test all siren functions after installation to assure proper operation. Test vehicle operation to assure no damage to vehicle.

Keep These Instructions - Keep these instructions in the vehicle or other safe place for future reference. Advise the vehicle operator of the location.

UNPACKING

Inspect contents for shipping damage. If found **alert carrier immediately**.

Contact supplier immediately if any components are missing.

Contents of box should include the following items:

Qty	Item
1	Amplifier Unit with attached Microphone (SA-400-11 14)
1	Bracket, Microphone Clip with mounting screws (CP3633)
1	Bracket, 'U' Dash Mount (CP3571)
2	Bolts, 'U' Mounting Bracket (CP3966)
1	Cable Assembly, 9-P Wiring Harness 3FT (CP2560)
1	Instruction Manual (CP4931 This Manual)

OPTION SWITCHES

An internal 8-position DIP switch on the circuit board may be changed to select various options. The cover for the unit must be removed to access the DIP switch.

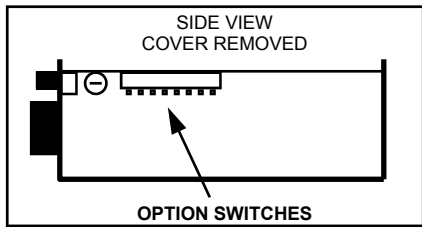

Accessing Option Switches - The cover is held in place by a snap-fastener on the back of the unit. While holding the cover on the sides press hard with your fingers on the back of the unit. The chassis will slide out the front.

Adjusting Option Switches - the DIP Switch is located on the internal PCB assembly board toward the right side of the unit. Switch 1 is toward the back of the unit. Switch 'ON' position is toward the inside side of the unit.



Default Setting Shown
SW-7 and SW-8 ON

SW-1 Not Used... Leave Off.

SW-2 Not Used... Leave Off.

SW-3 Horn Disable - Turn this switch ON to disable Horn tone.

SW-4 Not Used... Leave Off.

SW-5 Not Used... Leave Off.

NOTE: Earlier models with S/N lower than 04190000 have a 5 position DIP switch and only offer the traditional auxiliary input.

Traditional Auxiliary Input - On earlier models of the SA-400, the auxiliary input is activated with positive (+VDC) **AND** negative (-VDC). A normally open horn ring circuit or switch is required for proper operation. Possibly use this setting if the auxiliary input is wired for an earlier SA-400.

SW-6	SW-7	SW-8	Auxiliary Input Activation Polarity
ON	OFF	OFF	Positive and Negative Activation (Traditional Auxiliary)
OFF	ON	ON	Positive Only Activation (Factory Default)
OFF	ON	OFF	Negative Only Activation

MOUNTING

The mounting bracket supplied can be installed above or below the unit. Choose a mounting location convenient to the operator and away from any air bag deployment areas. Inspect behind mounting area for clearance. Assure adequate ventilation to prevent overheating. Consider wire routing and access to connections, as well as microphone bracket placement. Install mounting bracket to vehicle using 1/4" hardware (not supplied).

If mounting in a rack or console, make sure that mounting bolts do not enter case more than 1/4".

ELECTRICAL CONNECTIONS

Electrical connections to the unit are made using the wiring harness supplied. If the unit needs service the connector can be easily removed without unwiring the harness.

The power supply for the unit must be capable of delivering peak currents up to 50 amps for adequate short circuit protection and reliable operation. The preferred source is directly at the vehicle battery. A fuse on the rear of the unit protects from overload.

Disconnect vehicle battery before making any electrical connections.

Extend leads using adequately sized wiring and terminals or splices.

Wire Size and Termination - The diagram shows the minimum wire size used for each connection, along with recommended lead color. If the wire is longer than 10 ft. use the next larger wire size. Use only high quality crimp connectors for installation on the vehicle.

Radio Input Connection (Optional) - Connect 1 lead to each terminal of the radio speaker or output connector. The input is isolated and polarity is not important. May need to set RADIO VOLUME ADJUST on side of unit.

Auxiliary Input Connection (Optional) - Used for Siren Control. Performs the same function as Siren push-button. Typically connected to the horn ring circuit of the vehicle or other momentary switch. See below for further details on activation polarity.

NOTE: Permanent disconnection of the vehicle horn is NOT recommended.

Traditional Auxiliary Input Activation - On earlier models of the SA-400, the auxiliary input is activated with positive (+VDC) **AND** negative (-VDC). A normally open horn ring circuit or switch is required for proper operation.

Possibly use this setting if the auxiliary input is wired for an earlier SA-400.

See OPTION SWITCHES section for further details.

Polarity Selectable Auxiliary Input Activation - The auxiliary input may be activated with positive (+VDC) **OR** negative (-VDC).

See OPTION SWITCHES section for further details.

ELECTRICAL CONNECTIONS CONTINUED

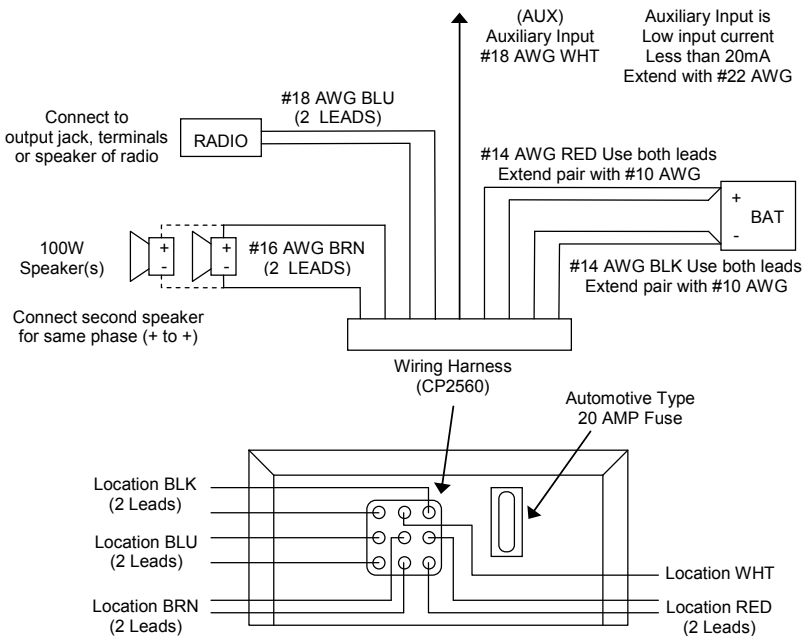
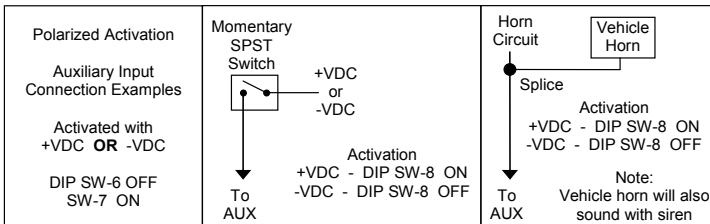
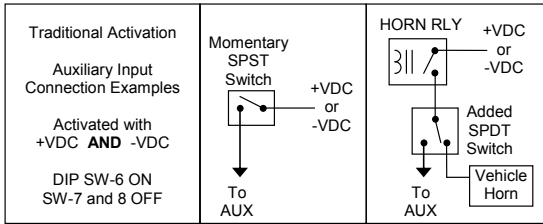

OPERATION

WARNING **Sound Hazard** - Sound level from siren speaker (>120dBA @ 10 feet) may cause hearing damage. Do not operate siren without adequate hearing protection for you and anyone in immediate vicinity. (Ref. OSHA 1910.95 for occupational noise exposure guidelines)



GENERAL

Wail, Yelp, and Phaser tones have been replaced with a cycling on/off Horn function. Horn Cycling is quicker switching toward Phaser position.

SELECTOR SWITCH

The 6-position rotary selector switch controls the primary operating mode of the siren.

Radio - Also known as Radio Repeat, this function amplifies a radio speaker input for re-broadcast outside the vehicle. No Horn or PA operation is available in this position.

The radio must be connected and RADIO VOLUME ADJUSTed for this mode to function.

Horn - A standby mode that allows Horn Override.

Man - Also a standby mode that allows Horn Override.

Wail - Replaced with Horn Cycle 1 which is 3 seconds on and 5 seconds off.

Yelp - Replaced with Horn Cycle 2 which is 2 seconds on and 2 seconds off.

Phaser - Replaced with Horn Cycle 3 which is 1 second on and 1 second off.

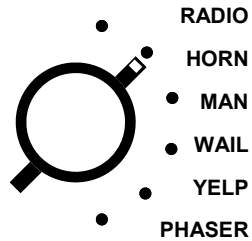

Rotary Switch	Operating Mode	Activate Siren push-button or Auxiliary Input
Radio	Radio	No Change
Horn	Silent	Horn
Man	Silent	Horn
Wail	Horn Cyc 1	Horn
Yelp	Horn Cyc 2	Horn
Phaser	Horn Cyc 3	Horn

MICROPHONE (PA Override)

The attached noise-canceling microphone is used for public address operation and overrides any siren tone when the push-to-talk button on the side of the microphone is pressed.

PA VOL

This control adjusts the PA volume. With the vehicle parked, set the PA volume to the maximum level with no feedback (squeal).



SIREN SWITCH

This momentary push-button switch provides Horn Override in all modes except Radio.



AUXILIARY INPUT

During installation an auxiliary input may be connected to the horn ring or other switching device. It provides the same operation as pressing the Siren push-button.

RADIO VOLUME

The radio repeat volume level is set using an adjustment inside the case just behind the PA volume control. Press on the rear of the case to open the unit. Set the Selector Switch to the Radio position and turn on the power. With the radio volume itself set to a normal level, set the siren radio volume adjust control to the desired level. Turn off power and press the unit back into the case.

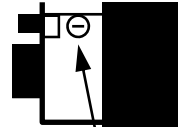

RADIO ADJUST

SERVICE

This unit is designed to provide years of reliable service under even the worst conditions. Many times there may appear to be a problem with the unit when the true problem is in the speaker(s) or improper installation. The following chart shows typical symptoms and possible causes.

A blown rear panel fuse doesn't necessarily mean that the unit is bad. If a speaker or speaker lead is shorted this fuse will blow before the unit is damaged. Disconnect the SPKR leads and replace the fuse. If the siren emits a sound (Horn Cycle 3) when in the Phaser position it is OK. Check the speaker(s) or leads for possible shorting.

PROBLEMS

Symptom	Possible Cause	Check
No power or siren output	Power switch not turned on Bad speaker(s) Connector loose Fuse blown Loose connection at power source	Does backlighting come on? Do you hear a "pop" when turned on? With siren on, phaser selected, listen for faint Horn Cycle 3 tone in amplifier. Is an external fuse or circuit breaker used? Are the negative leads connected to a good ground?
No Horn - PA works	High Voltage Protection Mic button stuck Horn disabled	Input voltage must be less than highest rated voltage. Does mic button release properly? Is Horn Disable option switch turned on?
No PA	PA volume not set properly Selector in Radio position	Have you tried turning the PA volume control? PA is not available in the Radio position
Distorted siren sound	Speaker assembly loose Intermittent Aux Input connection Low vehicle voltage	Is the speaker bell or tip loose? Is the Aux Input used and wired properly? Input voltage must be greater than lowest rated voltage.
Intermittent siren tone (not Horn Cycle x)	High Voltage Protection Connector loose Bad power connection Mic button activation Circuit breaker in supply connection	Is the vehicle voltage regulator working properly? Is the connector tight on the back of the unit? Is there a loose connection on a power lead? Is something lying on the microphone? Is a circuit breaker used with at least a 50A rating?
Horn function stuck on	Siren switch stuck Aux Input improperly connected	Does the Siren switch return fully when released? Is the Aux Input used and wired properly? Aux Input is activated with positive or negative.
No Radio	Unit not connected to radio Radio volume too low	Is the radio connected properly to the unit? Can you here the radio in the vehicle? Have you tried turning the RAD volume control?

See www.carsonsirens.com for additional information.

or contact our Service Department at:

E-mail service@carsonsirens.com or Phone (888) 577-6877

PARTS and ACCESSORIES

The following parts and accessories are available from Carson Manufacturing Company, Inc.:

Part	Description
CP5018	Button, Switch Cap Red (for Siren pushbutton)
CP4732	Control, 1K Vertical Trimmer (Radio Volume)
CP3547	Control, 350 Ohm Mini-Pot (PA volume)
ES00026-03	Cover (not including chassis)
ATO/ATC 20A	Fuse, 20 Amp Automotive
CP4852	Knob, Selector Switch
CP4853	Knob, PA Volume Control
CP4826	Label, SA-400-10 Front Panel
ED1680	Lead Asmb, Chassis Plug (internal)
CP4750	Microphone, Noise Canceling w/Connector
SR-15-1	Microphone Strain Relief
CP5014	Nut, 1/4-40 Dress (for Siren pushbutton)
CP4822	Switch, Momentary Push Button, Right Angle (Siren Pushbutton)
CP3962	Switch, Power Rocker
CP3548	Switch, Rotary 6-Pos. Selector
CP4119	Transistor, output (2 required)
Accessory	Description * - standard accessory supplied with unit
CP4899	Bracket, Flush Mounting
CP3633 *	Bracket, Microphone Clip with mounting screws
CP3571 *	Bracket, 'U' Dash Mount
CP3966 *	Bolts, 'U' Mounting Bracket (typically 2 ea required)
CP2560 *	Cable Assembly, 9-P Wiring Harness 3FT
CP4931 *	Manual, SA-400-11 Instruction

See www.carsonsirens.com for additional information.

or contact our Service Department at:

E-mail service@carsonsirens.com or Phone (888) 577-6877

RETURN

If you have any questions concerning this or any other Carson product, please contact our **Technical Service Department** at (888) 577-6877. Many issues can be handled over the phone. We can also be reached via e-mail at service@carsonsirens.com

If a product must be returned for any reason, please contact our Technical Service Department to obtain a Returned Merchandise Authorization number (RMA#) before you ship the product to Carson. Please write the RMA# clearly on the package near the mailing label. Be sure to provide a return address, contact and phone number, along with a brief description of the problem.

LIMITED WARRANTY

Carson Manufacturing Company, Inc. warrants this new product to be free from defects in material and workmanship, under normal use and service, for a period of five (5) years from the date of delivery to the first user-purchaser.

During this warranty period the obligation of Carson Manufacturing is limited to repairing or replacing, as Carson Manufacturing may elect, any part or parts of such product which after examination by Carson Manufacturing is determined to be defective in material and/or workmanship.

This warranty does not cover labor charges for removal or re-installation of the product. Fuses and lamps are not covered under this warranty.

This warranty does not extend to any unit that has been subjected to abuse, misuse, improper installation or which has not been adequately maintained, nor to units which have problems related to service or modification at any facility other than the manufacturer.

THERE ARE NO OTHER WARRANTIES, EXPRESSED OR IMPLIED, INCLUDING BUT NOT LIMITED TO, ANY IMPLIED WARRANTIES OF MERCHANTABILITY OR FITNESS FOR A PARTICULAR PURPOSE. IN NO EVENT SHALL CARSON MANUFACTURING COMPANY, INC. BE LIABLE FOR ANY LOSS OF PROFITS OR ANY INDIRECT OR CONSEQUENTIAL DAMAGES ARISING OUT OF ANY SUCH DEFECT IN MATERIALS OR WORKMANSHIP.