

CARSON

Carson Manufacturing Co., Inc.
5451 North Rural Street
Indianapolis, IN 46220
Phone: (888) 577-6877 Fax: (317) 254-2667
www.carsonsirens.com

SC-411RS-20 14 REMOTE SIREN AMPLIFIER WITH LIGHT CONTROL

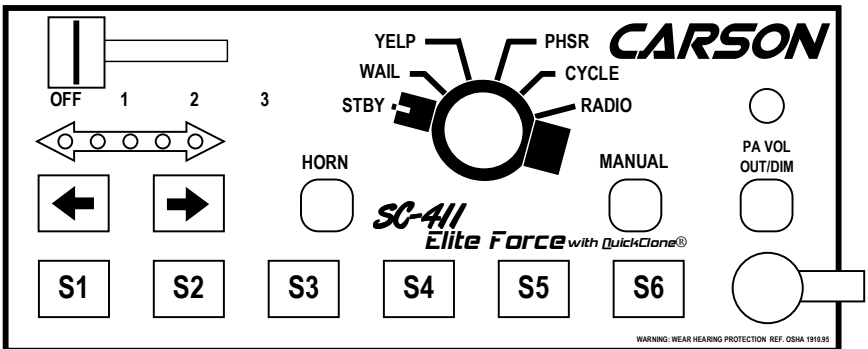

INSTALLATION AND OPERATING INSTRUCTIONS

Carson is a trademark of Carson Manufacturing Company, Inc.

WARNING Sound Hazard - Sound level from siren speaker (>120dBA @ 10 feet) may cause hearing damage. Do not operate siren without adequate hearing protection for you and anyone in immediate vicinity. (Ref. OSHA 1910.95 for occupational noise exposure guidelines)

TABLE OF CONTENTS

- GENERAL DESCRIPTION 3
- SPECIFICATIONS 3
- INSTALLATION 4
 - SAFETY PRECAUTIONS 4
 - UNPACKING 4
 - MOUNTING - Control Head 4
 - MOUNTING - Amplifier 4
 - ELECTRICAL CONNECTIONS - Amplifier 4
 - OPTIONAL CONNECTIONS - Amplifier 4
 - AMPLIFIER WIRING DIAGRAM 5
- OPTION SETTINGS 6
 - Enter/Exit Program Mode, Reset 6
 - S1 - S6 Switch Operation 7
 - Lever / S1 - S6 Switch Linkage 7
 - Option Set 1 (Input polarity, timed override, sweep/intersection, auto siren) 8
 - Option Set 2 (Tone enables, short manual, lever progression) 9
 - Option Set 3 (Alert, siren/lever video, center only, instant on) 10
- OPERATION 11
 - POWER ON/OFF 11
 - SIREN CONTROLS 11
 - Rotary Switch 11
 - Manual Button 11
 - Horn Button 11
 - PA 11
 - SIRCTRL Input (Optional) 12
 - LITCTRL Input (Optional) 12
 - CUTOUT Input (Optional) 12
 - Timed Override (Optional) 12
 - Sweep/Intersection Function (Optional) 12
 - Second Speaker Output (Dual Tone) 12
 - LIGHT SYSTEM CONTROLS 12
 - Lever Switch 12
 - Automatic Siren 12
 - Auxiliary Control Switches 12
 - Arrow Stick Control Switches 12
 - Switch Legends 12
 - OUT/DIM 12
 - Video Trigger Output 12
 - Alert 12
 - DIAGNOSTICS 13
 - PROGRAM TRANSFER 13
- SERVICE 14
- PROBLEMS 14
- PARTS 14
- RETURN 15
- LIMITED WARRANTY 15
- INSTALLATION CONFIGURATION RECORD 16

NOTICE

This Carson siren is intended for use by authorized personnel only. It is the user's responsibility to ensure they understand and operate this emergency warning device in compliance with all applicable city, state and federal laws and regulations.

Due to continuous product improvements, we must reserve the right to change any specifications and information, contained in this manual at any time without notice.

Carson Manufacturing Co., Inc. makes no warranty of any kind with regard to this manual, including, but not limited to, the implied warranties of merchantability and fitness for a particular purpose.

Carson Manufacturing Co., Inc. shall not be liable for errors contained herein or for incidental or consequential damages in connection with the furnishing, performance, or use of this manual.

GENERAL DESCRIPTION

The SC-411RS Remote Light Control/Siren is a premium unit designed for one or two 100W speaker use. The primary operating modes are Radio, Cycler, Standby, Yelp, Wail, and Phaser. A Noise Canceling PA Override and push-button Horn Override are available in all modes except Radio. A push-button is provided for toggling between Wail, Yelp, and Phaser tones, and Manual siren control in silent modes. The Phaser tone can be optionally replaced by Two-Tone or disabled entirely. Auxiliary inputs are provided for connection to horn ring circuit or switch. A latching siren cutout input is provided for connection to a door switch, etc. to stop siren tones when exiting the vehicle. PA volume control is on the front panel while Radio volume control is on the amplifier. The front panel is backlit with LED's for night visibility, dimmable with a front panel switch and/or connection to dash lights. The siren circuits utilize short circuit, high voltage, and reverse polarity protection for maximum service life. An indicator light on face is provided for siren output diagnostics.

The SC-411RS also provides a 4-position lever switch with LED indicators for primary lighting system control of up to 50 amps total and automatic siren tone in last position. Six programmable lighted push-button switches with replaceable legends provide auxiliary lighting or other device control up to 10 amps per switch. Each output is fused and monitored with visual and audible indicators for diagnostics. An alert periodically sounds (may be disabled) when outputs are on to help prevent leaving lights on unintentionally. A video camera trigger output is activated with the lever switch or programmed auxiliary switches. Two switches are dedicated to arrow stick control (left, right, center) with function indication and specific control outputs.

All optional settings are programmed from the remote head face. These settings are synchronized between the head and amplifier using our QuickClone® duplication technology, a quick-copy feature for simple transfer of option setting among multiple heads and amplifiers for efficient fleet installations.

SPECIFICATIONS

Siren Section											
Input Voltage	10 - 16 VDC (negative ground)										
Input Current	16 AMPS (@14 VDC - two 100W speakers)										
Standby / Off Current	Less than 300 ma / less than 20 ma										
Audio Frequency	200Hz - 10 kHz ± 3db										
Audio Distortion	Less than 7% @1 kHz - two 100W speakers										
Audio Output	80 watts (@14 VDC - two 100W speakers)										
Audio Input	400 ohms ± 10%										
Output Power	210 WATTS RMS MAX. (15 VDC - two 100W speakers)										
Siren Frequency	700Hz - 1500Hz (Two-Tone and Horn = 435 & 585Hz)										
Tones / Cycle Rates	<table border="0"> <tr> <td>Horn</td> <td>Wail</td> <td>Yelp</td> <td>Phaser</td> <td>Two-Tone</td> </tr> <tr> <td>109 CPS</td> <td>13 CPM</td> <td>190 CPM</td> <td>15 CPS</td> <td>60 CPM</td> </tr> </table>	Horn	Wail	Yelp	Phaser	Two-Tone	109 CPS	13 CPM	190 CPM	15 CPS	60 CPM
Horn	Wail	Yelp	Phaser	Two-Tone							
109 CPS	13 CPM	190 CPM	15 CPS	60 CPM							
High Voltage Protection	16 - 18 VDC will cause siren output to cease, resume at normal voltage										
Short Circuit Current	50 AMPS (supply circuit must be capable of supplying this)										
Operating Temp.	-15° F to +140° F										
Controls	6-position rotary mode switch (Radio, Cycler, Standby, Yelp, Wail, and Phaser). Momentary push-button Horn switch. Momentary push-button Manual/Tone toggle switch. Momentary push-button Dimming switch. Enable input (positive) to turn on unit. Auxiliary siren input programmable for positive or negative operation. Auxiliary light control input programmable for positive or negative operation. Cutout input programmable for positive or negative latching operation. Face-programmable option settings.										
Connections (Rem. 12-Term Blk)	(2) Neg, (2) Spkr, (2) Radio, Power, Siren Ctrl, Light Ctrl, Cutout, Backlit (#28-#12 AWG)										
Light Control Section											
Controls	4-position lever switch with position 3 siren activation and LED indicators 8 - on/off lighted push-button switches with replaceable legends										
Current (Lever Switch)	20 AMPS per circuit, 50 AMPS total										
Current (Aux. Sw.)	10 AMPS per switch, 30 AMPS total										
Connections (Removable 3-Term Block) (Removable 10-Term Block)	Power Input - (2) screw terminal inputs (#22 to #6 AWG) 50A max each, external fuse reqd. Lever Switch - (3) outputs (#22 to #10 AWG), 20A max each Aux. Switches - (6) outputs (#22 to #12 AWG), 10A max each Left, right & center arrow stick control outputs (#22 to #12 AWG), 0.2A max each Video control output (#22 to #12 AWG), 0.2A max										
General											
Head/Amplifier Interconnect	CAT 5e cable 25ft (supplied)										
Control Head Mounting	Flush, surface or bracket mount (supplied)										
Size	Control Head: 6-1/8" X 2-5/8" X 1-1/4" Amplifier: 8-3/4" X 8-1/4" X 2-1/8"										
Shipping Weight	6 LBS.										

INSTALLATION

Proper installation of the unit is essential for years of safe, reliable operation. Please read all instruction **before** installing the unit. Failure to follow these instructions can cause serious damage to the unit or vehicle and may void warranties.

SAFETY PRECAUTIONS

For the safety of the installer, vehicle operator, passengers and the community please observe the following safety precautions. **Failure to follow all safety precautions and instructions may result in property damage, injury or death.**

Qualifications - The installer must have a firm knowledge of basic electricity, vehicle electrical systems and emergency equipment.

Mounting - Mount the control head for easy access by the vehicle operator. DO NOT mount in air bag deployment area. Assure clearances before drilling in vehicle. Mount the amplifier in a protected area with at least 1" clearance on all sides for heat dissipation.

Wiring - Use wiring capable of handling the current required. Make sure all connections are tight. Route wiring to prevent wear, overheating and interference with air bag deployment. Install and check all wiring before connection to vehicle battery.

Testing - Test all siren functions after installation to assure proper operation. Test vehicle operation to assure no damage to vehicle.

Keep These Instructions - Keep these instructions in the vehicle or other safe place for future reference. Advise the vehicle operator of the location.

WARNING



Sound Hazard - Sound level from siren speaker (>120dBA @ 10 feet) may cause hearing damage. Do not operate siren without adequate hearing protection for you and anyone in immediate vicinity. (Ref. OSHA 1910.95 for occupational noise exposure guidelines)

UNPACKING

Inspect contents for shipping damage. If found **alert carrier immediately**. Contents should include control head with attached microphone, amplifier, (2) mounting brackets with screws, microphone bracket with screws, legend sheet, (3) connectors, 25ft CAT 5e interconnect cable and these instructions. Contact supplier immediately if any components are missing.

MOUNTING - Control Head

Choose a mounting location convenient to the operator and away from any air bag deployment areas. Inspect behind mounting area for clearance. Consider wire routing and microphone bracket placement. Connect interface cable prior to mounting.

The control head can be surface, flush or bracket mounted using the supplied brackets and hardware. If longer fasteners are used **assure that screws do not enter rear of unit more than 3/8"**.

MOUNTING - Amplifier

Choose a mounting location that will assure at least 1" clearance on all sides with adequate ventilation to prevent overheating. Inspect behind mounting area for clearance. Consider wire routing and access to connections. Make all wiring connections prior to mounting.

ELECTRICAL CONNECTIONS - Amplifier

Electrical connections to the unit are made using removable terminal blocks and screw terminals. Labels on the unit identifies each terminal function. A CAT-5e cable connects between the control head and the amplifier. If the unit needs service the plugs can be easily removed without unwiring. Connect all wires prior to applying power to the unit and prior to final mounting. Attach leads by stripping 3/8", inserting into plug and clamp by tightening screw. Make sure the screw is tight and the wire can't be pulled out. **Failure to adequately tighten the screw can result in improper operation or burning the connector and wire.**

POWER Input - This is like a power switch for the entire unit. Connect to a positive circuit controlled by the vehicle ignition switch, usually a terminal at the vehicle fuse panel.

OPTIONAL CONNECTIONS - Amplifier

SIRCTRL Input - This input allows activation by an external source of either the Horn or other function. Settable for +12 (default) or ground activation.

LITCTRL Input - This input allows cycling by an external source through the lever switch positions. Settable for +12 (default) or ground activation.

CUTOUT Input - The Cutout Input turns off any siren tone output when activated, and remains off until a control is activated or changed. Settable for +12 (default) or ground activation.

RADIO Input - Connect to radio output terminals or its speaker. The **Radio Volume** control is on the amplifier and is a one time setting depending on the radio connected.

VIDEO Output - A video camera trigger output is activated high (+12) with the lever switch or programmed auxiliary switches. See OPTION SETTINGS section.

LFT-A, RGT-A, CTR-A Outputs - These 3 active high (+12) outputs are available for arrow stick control. LFT-A, RGT-A AND CTR-A outputs are active when center selected.

AMPLIFIER WIRING DIAGRAM

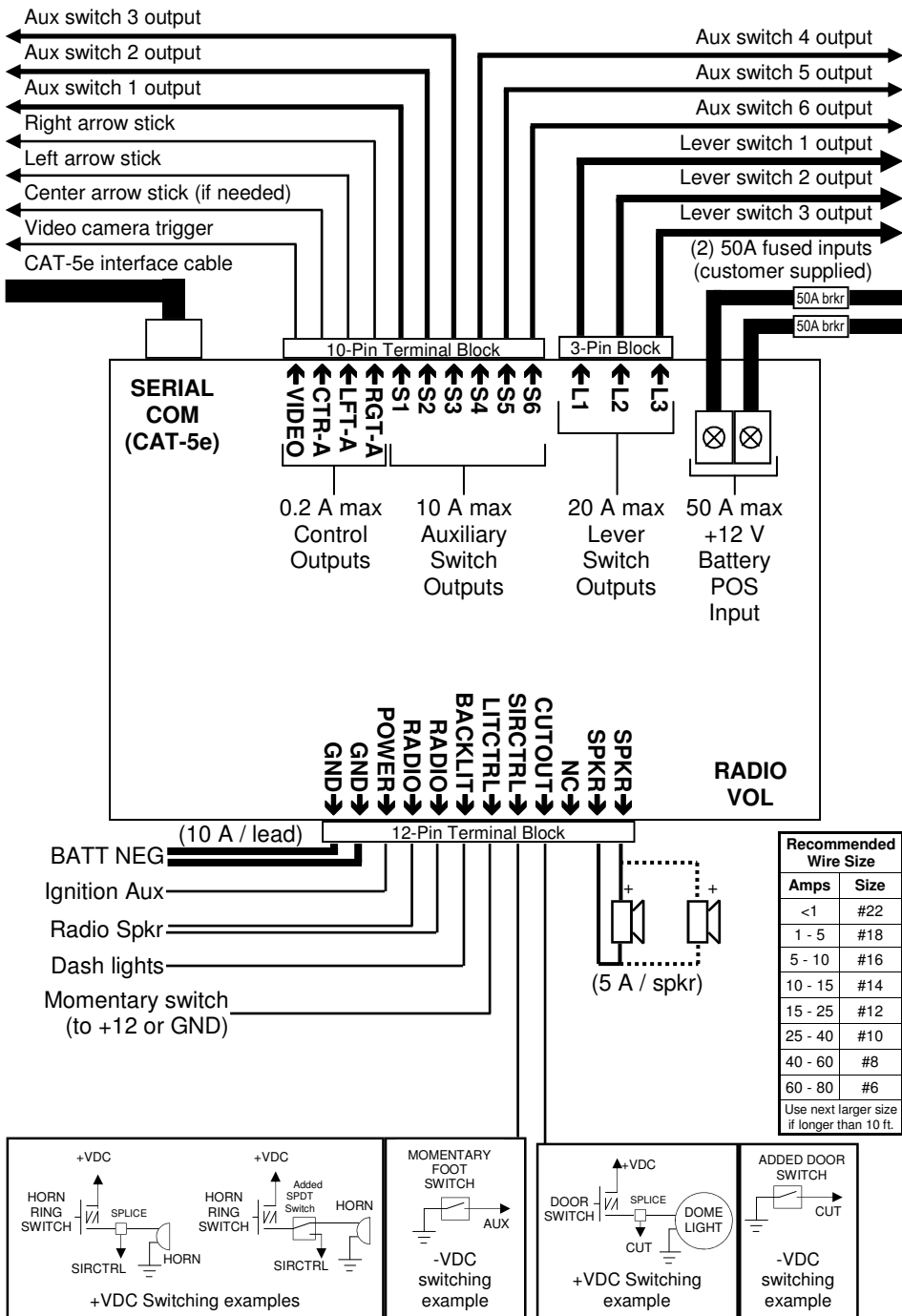

Recommended Wire Size	
Amps	Size
<1	#22
1 - 5	#18
5 - 10	#16
10 - 15	#14
15 - 25	#12
25 - 40	#10
40 - 60	#8
60 - 80	#6

Use next larger size if longer than 10 ft.

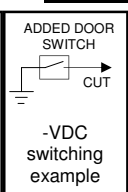
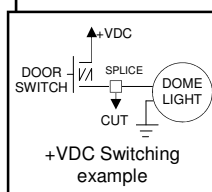
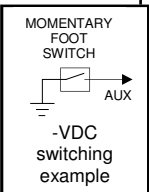
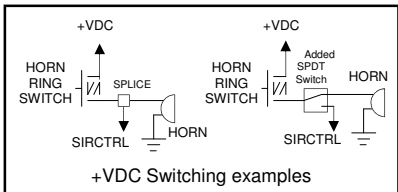

OPTION SETTINGS

Enter/Exit Program Mode, Reset

Option setting (programming) is done from the face of the control head. Unit must be turned on with POWER input. Make sure that lever switch is OFF and rotary switch is in STBY.

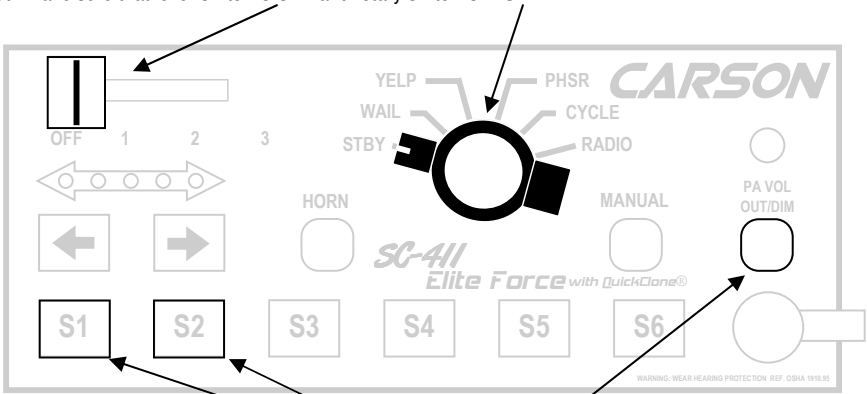

Enter the program mode by pressing and holding S1, S2 and OUT/DIM for 3 seconds.

The unit will beep 3 times and the backlighting will begin flashing to indicate that the unit is in program mode. It will continue to flash until program mode is exited by pressing and holding OUT/DIM for 3 seconds, saving the settings—the unit will emit a long beep.

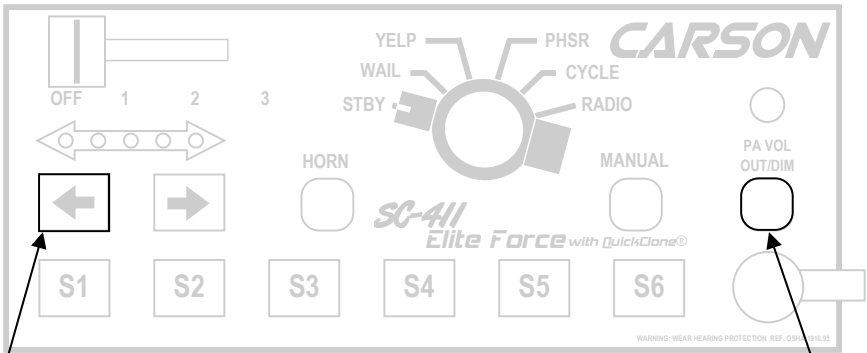

Press and hold for 3 seconds to **reset** to factory default.

Press for next step. Press and hold for 3 seconds to exit.

Program Mode Sections

Press OUT/DIM	Display	Programming
0↓	1+2+3, 1 or 2 or 3	S1-S6 Switch Operation, Lever / S1-S6 Switch Linkage
1↓	1 blinking	Option Set 1 (Input polarity, timed, swp/int, auto)
2↓	2 blinking	Option Set 2 (Tone enables, short manual, lever progression)
3	3 blinking	Option Set 3 (Alert, siren/lever video)

S1 - S6 Switch Operation

Lever switch OFF → 1, 2 & 3 all lit

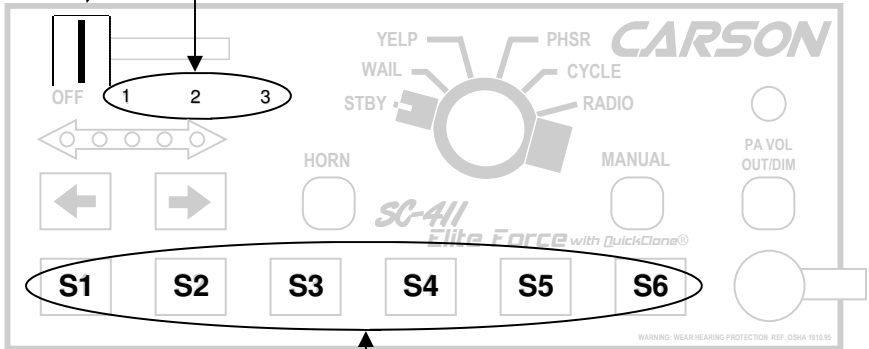

Change each switch's operation by momentarily pushing the switch.
See the table below for switch status definition.

1. Light ON - Push On / Push Off with video output trigger active (default)
2. Light OFF - Push On / Push Off with video trigger output deactivated.
3. Light flashing continuously - Momentary.
4. Light flashing with double pulse - Timed Momentary (Gun Lock Timer) for duration of 10 seconds.
5. Light flashing with triple pulse - Timed Momentary (Gun Lock Timer) for duration of 20 seconds.
6. The options with cycle through and repeat with each push of the button.

Note: Timed Momentary (Gun Lock Timer) is not be available for Lever switch linkage.

Lever / S1 - S6 Switch Linkage

Lever switch set to 1, 2 or 3 → 1, 2 or 3 lit

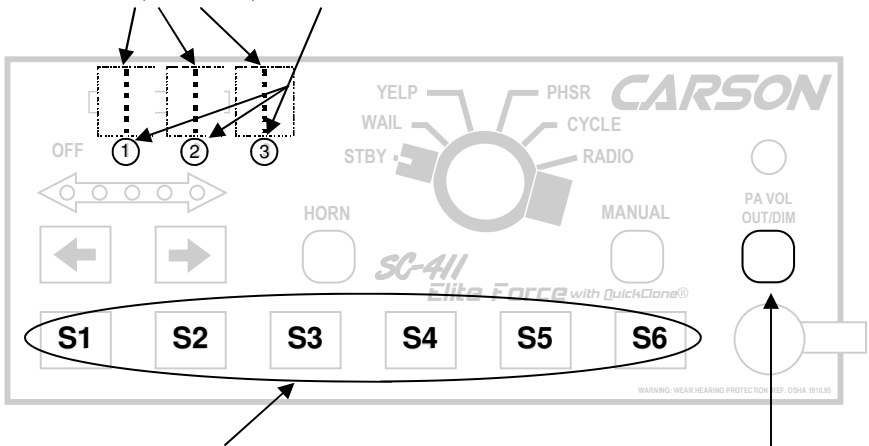

Press the desired auxiliary switch to turn on or off the light, linking it to the lever switch position.

NOTE: Timed Momentary (Gun Lock Timer) programmed switches cannot be used.

Press the OUT/DIM button momentarily to move into next section, or OUT/DIM for 3 seconds to save & exit.

Option Set 1

(Input polarity, timed override, sweep/intersection, auto siren)

Lever switch 1 light blinking

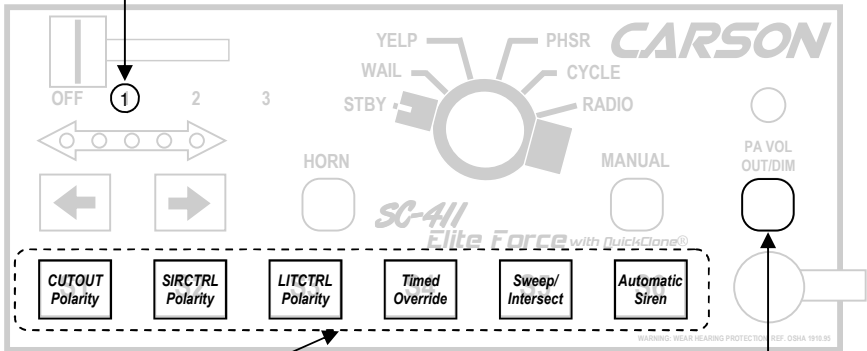

Momentarily press switch S1 - S6 to change.

Press the OUT/DIM button momentarily to move into next section, or OUT/DIM for 3 seconds to save & exit.

S1	S2	S3	S4	S5	S6	SWITCH
CUTOUT Polarity	SIRCTRL Polarity	LITCTRL Polarity	Timed Override	Sweep / Intersection	Automatic Siren	FUNCTION
ON - Pos Blink - Neg OFF - Disable	ON - Pos Blink - Neg OFF - Disable	ON - Pos Blink - Neg OFF - Disable	OFF ON	OFF ON	ON OFF	OPTIONS (Top is default)

S1 (CUTOUT Input), S2 (SIRCTRL Input), S3 (LITCTRL Input) - These inputs are normally activated by a 12V input (ON). Press the switch once until it FLASHES to change to ground activation. Press the switch again for OFF to disable.

S4 (Timed Override) - While the rotary switch is in Wail, Yelp or Phaser positions, momentarily pressing the Manual push button will override the Wail, Yelp or Phaser tone. With this option ON the unit automatically goes back to the previous tone after 10 seconds.

S5 (Sweep/Intersection Function) - While the rotary switch is in Wail, Yelp, or Phaser positions, momentarily activating the siren control input (SIRCTRL) will change the unit into sweep mode, where the tone automatically changes every few seconds. Press again to triple the change rate (intersection mode). Press again to go back, or press twice to cancel.

S6 (Automatic Siren) An Automatic Siren feature turns on the siren in the Wail mode when the Lever switch is in position 3.

Option Set 2

(Tone enables, short manual, lever progression)

Lever switch 2 light blinking

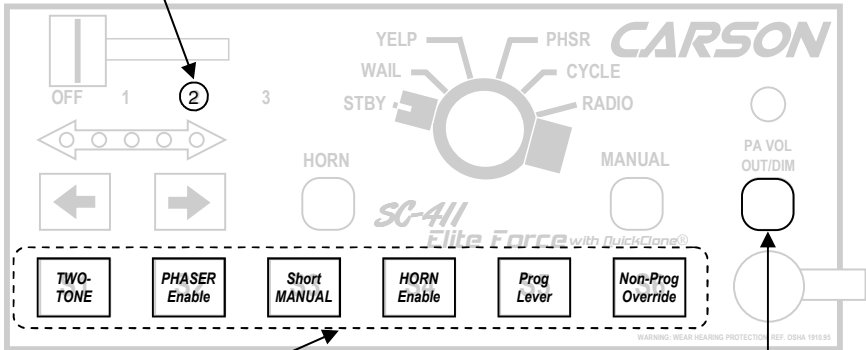

Momentarily press switch S1 - S6 to change.

Press the OUT/DIM button momentarily to move into next section, or OUT/DIM for 3 seconds to save & exit.

S1	S2	S3	S4	S5	S6	SWITCH
TWO-TONE	PHASER Enable	Short MANUAL	HORN Enable	Progressive Lever	Non-Progressive Override	FUNCTION
OFF - Phaser ON - Two-Tone	ON - Phaser OFF - Disable (Yelp)	OFF - Normal Manual ON - Short Manual	ON - Horn Enabled OFF - Disabled	ON - Progressive Lever Operation OFF - Non-Progressive Operation	OFF - Normal Progression ON - Non-Progressive Override	OPTIONS (Top is default)

S1 (Two-Tone Enable) - Two-Tone replaces Phaser tone when turned ON.

S2 (Phaser Enable) - Phaser (or Two-Tone) is disabled and replaced with Yelp when OFF.

S3 (Short Manual Enable) - The Manual siren tone will normally die out and stop when the Manual push-button is released. Turning option ON forces the Manual siren tone to stop immediately upon release.

S4 (Horn Enable) - Horn tone is disabled when turned OFF.

S5 (Progressive Lever) - As the lever switch is moved from off to position 3 outputs 1 and 2 stay on. Turn this option OFF For isolated operation, where each output is independent.

S6 (Non-Progressive Override) - With Progressive Lever option off, turning this option ON will turn on all 3 outputs when the lever switch is in position 3. Otherwise there is no effect.

Option Set 3
(Alert, siren/lever video)

Lever switch 3 light blinking

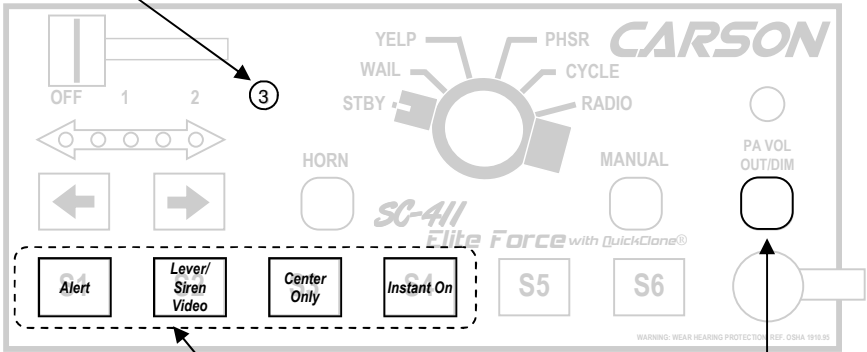

Momentarily press switch S1 - S4 to change.

Press the OUT/DIM button momentarily to move into next section, or OUT/DIM for 3 seconds to save & exit.

S1	S2	S3	S4	SWITCH
Alert	Lever/Siren Video	Center Only	Instant On	FUNCTION
ON - Alert Active OFF - Disable	ON - Lever/Siren Video OFF - Disable	OFF ON	OFF ON	OPTIONS (Top is default)

S1 (Alert Enable) - Alert provides a periodic "beep" at the control head to remind that a light is on. Turn off to disable this feature.

S2 (Lever/Siren Video) - VIDEO output is normally on when the Lever switch and/or Siren is active. Press switch to disable. (NOTE: this does not control the VIDEO Output for S1 - S6. See S1 - S6 Operation)

S3 (Center Only) - Only CTR-A output is on when center arrow stick selected.

S4 (Instant On) - Lever switch operates even when ENABLE input is off. Arrow stick buttons also operate.

NOTE: These option setting can be easily transferred to another vehicle. See PROGRAM TRANSFER.

OPERATION

This unit is designed for easy operation under the stress associated with high-speed pursuit. Most siren functions are accessible with one simple motion. Certain operational features are controlled by option settings and/or installation connections.

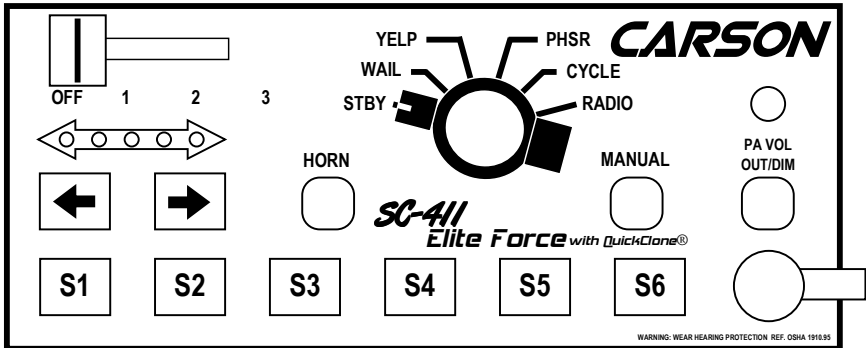

POWER ON/OFF

The unit is powered by the ignition switch.

SIREN CONTROLS

The **Rotary Switch** selects the primary operating mode of the siren.

RADIO - Also known as Radio Repeat, this function amplifies a radio speaker input for re-broadcast outside the vehicle. A radio must be connected and the Radio Volume Adjusted. No siren tones or PA are available in this position.

CYCLE - A standby position dedicated for Horn Ring Cycler 2 (HRC2). During installation, the siren control input must be connected to the horn ring or other switching device. Tap the horn ring to bring the unit out of standby into Wail tone. Repeatedly tapping the horn ring will cycle through Wail, Yelp, and Phaser tones. Tapping the horn ring twice quickly will stop the siren tones and return the unit to standby. Pressing and holding the horn ring will produce Horn tone until released.

STBY - A silent mode that allows Manual, Horn and Public Address operation.

WAIL - A slower changing tone used on highways.

YELP - A rapidly changing tone used in congested areas.

PHSR - A very rapidly changing tone used at intersections or in highly congested areas. May be replaced with Two-Tone (or Hi - Lo, a common European Tone) or disabled entirely.

MANUAL Button - Provides manual control of siren tone rise and fall while in Cycler or Standby. The falling tone may be stopped immediately by setting the Short Manual option. With rotary in WAIL, YELP, or PHSR this button toggles between tones.

HORN Button - Produces a simulated Air-Horn tone while pressed. Overrides all siren tones except Radio. Horn tone may be disabled.

PA - The noise-canceling microphone is used for public address operation and overrides any siren mode when the button on the side is pressed. Adjust the PA Volume and hold the microphone close to your lips for proper operation.

OPERATION

(Continued)

SIRCTRL Input (Optional) - During installation, the siren control input may be connected to the horn ring or other switching device. Activation of this input will produce Horn tone or other functions depending on Rotary Switch position as shown in the table below.

Rotary Position	Normal Tone	Horn Push-Button	Manual Push-Button	Siren Control Input (Horn Ring)
Radio	Radio	Radio (No Effect)	Radio (No Effect)	Radio (No Effect)
Cycler	Silent	Momentary Horn	Manual Siren	HRC2
Standby	Silent	Momentary Horn	Manual Siren	Momentary Horn
Wail	Wail	Momentary Horn	Wail/Yelp Toggle	Mom. Horn (Opt. SWP/INT)
Yelp	Yelp	Momentary Horn	Yelp/Phaser Toggle	Mom. Horn (Opt. SWP/INT)
Phaser	Phaser	Momentary Horn	Yelp/Phaser Toggle	Mom. Horn (Opt. SWP/INT)

LITCTRL Input (Optional) - During installation, the light control input may be connected to a momentary switch. Activation of this input will cycle through the lever switch positions, with the lever switch overriding if moved.

CUTOUT Input (Optional) - During Installation, the cutout input may be connected to the vehicle door switch or other switching device. Activation of this input will turn off any siren tone and remains off when deactivated until a siren control is changed.

Timed Override (Optional) - With Rotary Switch in Wail, Yelp, or Phaser mode, momentarily pressing the Manual push-button will toggle between tones overriding the Wail, Yelp, or Phaser tone. With this option selected the unit automatically goes back to the Wail, Yelp, or Phaser tone after 10 seconds.

Sweep/Intersection Function (Optional) - The Sweep function is an automatic sequence of Yelp, Phaser, and Horn tones allowing hands free operation. The Intersection function is a more rapid automatic sequence of Yelp, Phaser, and Horn tones allowing hands free operation through intersections.

With Rotary Switch in WAIL, YELP, or PHSR position, tap the horn ring to start Sweep function. Tap the horn ring again to start the faster Intersection function. Repeatedly tapping the horn ring will switch between Sweep and Intersection functions. Tapping the horn ring twice quickly will return to Wail, Yelp, or Phaser mode. Pressing and holding the horn ring will produce Horn tone until released. Then the siren will return to the Sweep or Intersection sequence.

LIGHT SYSTEM CONTROLS

A 4-position lever switch provides control of primary lighting functions. It also provides automatic activation of the siren. Six additional programmable pushbuttons provided for auxiliary lighting or other device control. Two dedicated switches operate directional control lights ("Arrow Stick"), with flashing indicators on the control panel. An optional Instant On feature allows use of the Lever Switch with the ignition off.

Lever Switch - The lever switch by default provides progressive (additive) control of lighting functions. The third position also provides Automatic Siren. The installer can change to non-progressive operation.

Automatic Siren - Position 3 of the lever switch provides Automatic Siren control. If the siren controls are set where there is no siren tone output, the Automatic Siren will override with Wail or other tone. The cutout input will stop the siren tone. This feature may be disabled.

Auxiliary Control Switches - Six lighted pushbutton switches are provided for various other lighting functions or device control. The switch lights Red when activated. The switches may also be programmed for different functions, and these switches may be combined with each lever switch position to automatically turn on and off.

Arrow Stick Control Switches - Two dedicated switches are provided to control traffic director lights on the vehicle. Press left or right buttons to set the direction. Turning on both will set the output to left, right and center. Lights show the operation selected. With Instant On set these switches operate when lever switch on.

Switch Legends - Different legends may be selected to match the device controlled. A sheet of labels is supplied.

OUT/DIM - The backlighting and indicator lights can be dimmed or turned off by repeatedly pressing the OUT/DIM button. An optional connection to the vehicle dash lights may also control this level. This button will light whenever a siren tone is produced.

Video Trigger Output - A video camera trigger output is activated with the lever switch in position 1, 2, or 3. Programmed auxiliary control switches may also activate the output.

Alert - While the lever switch or auxiliary control switches are on, an alert beep is sounded every 15 seconds. This can be optionally disable.

DIAGNOSTICS

The unit monitors all outputs for faults, which are usually traced to shorted circuits. The unit indicates these faults by flashing one or more lights and beeping. The following table shows fault indications and likely causes.

Control	Fault Indication	Likely Cause
Lever Switch light 1, 2 or 3	1, 2 or 3 flashes	Blown fuse at 1, 2 or 3
Switch 1 - Switch 6	Switch light flashes	Blown fuse at S1 - S6
Arrow Stick Switch	Switch light flashes	LFT-A, RGT-A or CTR-A output shorted (auto-reset)
Siren output	OUT/DIM light flashes	Blown siren fuse

PROGRAM TRANSFER (QuickClone®)

To facilitate programming of multiple vehicles this unit automatically synchronizes option settings between the control head and amplifier on power-up as shown. Transfer the settings to multiple vehicles by temporarily installing with a common control head, power-up/down (transferring options to the amplifier), then permanently install the supplied control head. On power-up the options are transferred from the amplifier to the control head.

Option Settings	Action
Head = Amp	Normal power-up
Head not Default and Amp not Default	Head settings transferred to Amp, power-up
Amp is Default and Head not Default	Head settings transferred to Amp, power-up
Amp not Default and Head is Default	Amp settings transferred to Head, power-up

If a control head or amplifier is sent in for service it will be set to default prior to return, and will automatically synchronize with the mating part on power-up.

SERVICE

This unit is designed to provide years of reliable service under even the worst conditions. Many times there may appear to be a problem with the unit when the true problem is in the speaker(s), controlled devices, or improper installation. The following chart shows typical symptoms and possible causes.

A blown siren fuse doesn't necessarily mean that the unit is bad. If a speaker or speaker lead is shorted the internal fuse will blow before the unit is damaged. Disconnect the speaker leads and replace the fuse. If the **OUT/DIM** light comes on with power on and Yelp selected it is OK. Check the speaker(s) or leads for possible shorting.

PROBLEMS

Symptom	Possible Cause	Check
No power or siren output	No power to POWER input Bad speaker Connector(s) loose Amplifier fuse blown Loose connection at power source	Does backlighting come on? Do you hear a "pop" when turned on? With siren on and Yelp selected, listen for tone in amplifier. Is an external fuse or circuit breaker used? Are the negative leads connected to a good ground?
No siren tone - PA works	High Voltage Protection Microphone button stuck Cutout activated Cutout Polarity set wrong	Input voltage must be less than highest rated voltage. Does microphone button release properly? Does the siren work when CUTOUT input is disconnected? Is the Cutout Input option properly configured?
No PA	PA volume not set properly	Have you tried adjusting the PA volume control?
Distorted siren sound	Speaker assembly loose Intermittent SIRCTRL Input connection Low vehicle voltage	Is the speaker bell or tip loose? Is the SIRCTRL Input used and wired properly? Input voltage must be greater than lowest rated voltage.
Intermittent siren tone	High Voltage Protection Connector loose Bad power connection Microphone button activation Circuit breaker in supply connection	Is the vehicle voltage regulator working properly? Is the connector tight on the back of the unit? Is there a loose connection on a power lead? Is something lying on the microphone? Are circuit breakers used with at least a 50A rating?
Horn function stuck on or Manual stuck on	Horn or Manual switch stuck SIRCTRL Input improperly connected SIRCTRL Input Polarity Option set wrong	Does the horn or manual switch return when released? Is the SIRCTRL Input used and wired properly? Is the Siren Control option properly configured?
No Radio	Unit not connected to radio Radio volume too low	Is the radio connected properly to the unit? Can you here the radio in the vehicle? Have you tried adjusting the radio volume control (amplifier)?
Wrong siren tone	Two-Tone option installed Aux Input set to wrong function	Is the Two-Tone option selected? Is the Sweep/Intersection option selected?
Phaser or Horn not working	Tone disabled	Is Phaser/Two-Tone Enable option selected? Is the Horn Enable option selected?
Automatic Siren not working	Automatic Siren disabled	Is the Automatic Siren Enable option selected properly?
Lever switch not working at all	No power to lever switch No ground at siren connector	Do the lever switch indicators light? Does the siren work?
Lever switch not working in some positions	Loose lever switch output connection	Does the lever switch indicator work in those positions? Is the corresponding fuse blown?
Aux control switch not working	No power to aux switches Loose aux switch output connection	Do the aux switch indicators light? Is the corresponding fuse blown?

PARTS

The following parts are available from Carson Manufacturing Company, Inc.:

Part	Description
ED1943	Kit, Control Head Mounting (2-brackets, screws and lockwashers)
ED1944	Kit, Lever Switch Replacement (Includes mounting screws & CP4960 knob)
CP4688-10	Connector, 10-Pin Removable Terminal Block
CP4688-12	Connector, 12-Pin Removable Terminal Block
CP5086-03	Connector, 3-Pin Removable Terminal Block
CP5090-25-BK	Cable, CAT5e 25ft Black
CP4990-150	Fuse, ATM 15 Amp Automotive Mini
CP4990-250	Fuse, ATM 25 Amp Automotive Mini
CP4960	Knob, Black Lever Switch
CP4852	Knob, Black Rotary Switch
CP4895	Label, Aux Output Legends
CP4750	Microphone, Noise Canceling w/Connector
CP3633	Microphone Bracket with mounting screws
SR-15-1	Microphone Strain Relief
CP4119	Transistor, Output (2 required) (Industry Standard TIP36C, must have metal tab)
CP5115	Manual, SC-411RD-20 Installation and Operating

RETURN

If you have any questions concerning this or any other Carson product, please contact our **Technical Service Department** at (888) 577-6877. Many issues can be handled over the phone. We can also be reached via e-mail at service@carson-mfg.com

If a product must be returned for any reason, please contact our Technical Service Department to obtain a Returned Merchandise Authorization number (RMA#) before you ship the product to Carson. Please write the RMA# clearly on the package near the mailing label. Be sure to provide a return address, contact and phone number, along with a brief description of the problem.

LIMITED WARRANTY

Carson Manufacturing Company, Inc. warrants this new product to be free from defects in material and workmanship, under normal use and service, for a period of five (5) years from the date of delivery to the first user-purchaser.

During this warranty period the obligation of Carson Manufacturing is limited to repairing or replacing, as Carson Manufacturing may elect, any part or parts of such product which after examination by Carson Manufacturing is determined to be defective in material and/or workmanship.

This warranty does not cover labor charges for removal or re-installation of the product. Fuses and lamps are not covered under this warranty.

This warranty does not extend to any unit that has been subjected to abuse, misuse, improper installation or which has not been adequately maintained, nor to units which have problems related to service or modification at any facility other than the manufacturer.

THERE ARE NO OTHER WARRANTIES, EXPRESSED OR IMPLIED, INCLUDING BUT NOT LIMITED TO, ANY IMPLIED WARRANTIES OF MERCHANTABILITY OR FITNESS FOR A PARTICULAR PURPOSE. IN NO EVENT SHALL CARSON MANUFACTURING COMPANY, INC. BE LIABLE FOR ANY LOSS OF PROFITS OR ANY INDIRECT OR CONSEQUENTIAL DAMAGES ARISING OUT OF ANY SUCH DEFECT IN MATERIALS OR WORKMANSHIP.

INSTALLATION CONFIGURATION RECORD

Terminal	AWG	Color	Connected to	Terminal	AWG	Color	Connected to
POS (2)				L1			
GND (2)				L2			
POWER				L3			
RADIO (2)				S1			
BACKLIT				S2			
LITCTRL				S3			
SIRCTRL				S4			
CUTOUT				S5			
SPKR				S6			
SPKR				RGT-A			
NC	X	X	X	LFT-A			
VIDEO				CTR-A			

S1—S6 Operation:						
Blank=Default, V=No Video, M=Momentary, 10 or 20=Hold Time						
Lever / S1 - S6 Switch Linkage: Blank=None, #=Pos						
	S1	S2	S3	S4	S5	S6
Operation						
Association						

Option Set 1			Option Set 3		
Option	Default	Setting	Alert Enable	ON	<input type="checkbox"/> ON <input type="checkbox"/> OFF
Cutout Input	POS	<input type="checkbox"/> POS <input type="checkbox"/> NEG <input type="checkbox"/> OFF	Lever/Siren Video	ON	<input type="checkbox"/> ON <input type="checkbox"/> OFF
Siren Control	POS	<input type="checkbox"/> POS <input type="checkbox"/> NEG <input type="checkbox"/> OFF	Center Only	OFF	<input type="checkbox"/> ON <input type="checkbox"/> OFF
Light Control	POS	<input type="checkbox"/> POS <input type="checkbox"/> NEG <input type="checkbox"/> OFF	Instant On	OFF	<input type="checkbox"/> ON <input type="checkbox"/> OFF
Timed Override	OFF	<input type="checkbox"/> ON <input type="checkbox"/> OFF	General Information		
Sweep/Intersection	OFF	<input type="checkbox"/> ON <input type="checkbox"/> OFF	Vehicle ID		
Automatic Siren	ON	<input type="checkbox"/> ON <input type="checkbox"/> OFF	Control Head S/N		
Option Set 2			Amplifier S/N		
Two-Tone	OFF	<input type="checkbox"/> ON <input type="checkbox"/> OFF	Notes:		
Phaser Enable	ON	<input type="checkbox"/> ON <input type="checkbox"/> OFF			
Short Manual	OFF	<input type="checkbox"/> ON <input type="checkbox"/> OFF			
Horn Enable	ON	<input type="checkbox"/> ON <input type="checkbox"/> OFF			
Progressive Lever	ON	<input type="checkbox"/> ON <input type="checkbox"/> OFF			
Non-Prog Override	OFF	<input type="checkbox"/> ON <input type="checkbox"/> OFF			

Installed by:	Date:
---------------	-------