

CARSON

Carson Manufacturing Co., Inc.
5451 North Rural Street
Indianapolis, IN 46220
Phone: (888) 577-6877 Fax: (317) 254-2667
www.carsonsirens.com

SC-1012-20 SIREN AMPLIFIER W/ LIGHT CONTROL

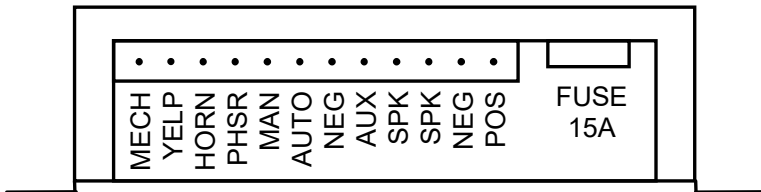
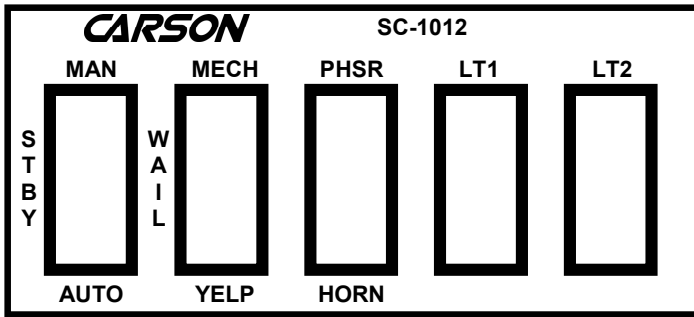

INSTALLATION AND OPERATING INSTRUCTIONS

Carson is a trademark of Carson Manufacturing Company, Inc.

WARNING Sound Hazard - Sound level from siren speaker (>120dBA @ 10 feet) may cause hearing damage. Do not operate siren without adequate hearing protection for you and anyone in immediate vicinity. (Ref. OSHA 1910.95 for occupational noise exposure guidelines)

TABLE OF CONTENTS



GENERAL DESCRIPTION.....	2
SPECIFICATIONS	3
UNPACKING	3
INSTALLATION	3
SAFETY PRECAUTIONS	3
MOUNTING	3
OPTION SWITCHES	4
ELECTRICAL CONNECTIONS	4-5
OPERATION.....	6
POWER ON/OFF	6
SIREN CONTROLS.....	6
Man - Standby - Auto Selector Switch	6
Mech - Wail - Yelp Selector Switch.....	6
Phaser Button Switch	6
Horn Button Switch	6
Auxiliary Input Functions	6
Horn Ring Cycler 2 (HRC2).....	6
LIGHT CONTROLS	6
LT1 and LT2 Lighted Rocker Switches	6
SERVICE.....	7
PROBLEMS	7
PARTS and ACCESSORIES	7
RETURNS	8
WARRANTY	8

GENERAL DESCRIPTION

The SC-1012 Remote Control Siren Amplifier with Light Control is designed for single 100W speaker use.

The primary operating modes are Mechanical, Wail, Yelp, and Standby selected by 3-position rocker switches. Momentary Horn Override, Momentary Phaser Override or push-on/push-off Phaser operation while in the Mechanical, Wail, and Yelp modes. Manual siren control of Mechanical, Wail, and Yelp. Lights are controlled with two rocker switches. The SC-1012 may be controlled with supplied switch panel or user supplied switches.

A DIP switch provides options to change tones, disable tones, HRC2 operation, and auxiliary input polarity. The units utilize short circuit, high voltage, and reverse polarity protection systems for maximum service life.

WARNING   **Sound Hazard** - Sound level from siren speaker (>120dBA @ 10 feet) may cause hearing damage. Do not operate siren without adequate hearing protection for you and anyone in immediate vicinity. (Ref. OSHA 1910.95 for occupational noise exposure guidelines)

NOTICE

Due to continuous product improvements, we must reserve the right to change any specifications and information, contained in this manual at any time without notice.

Carson Manufacturing Co., Inc. makes no warranty of any kind with regard to this manual, including, but not limited to, the implied warranties of merchantability and fitness for a particular purpose.

Carson Manufacturing Co., Inc. shall not be liable for errors contained herein or for incidental or consequential damages in connection with the furnishing, performance, or use of this manual.

See www.carsonsirens.com for latest information.

SPECIFICATIONS

Siren Section	
Input Voltage	10 - 16 VDC (negative ground)
Input Current	8 AMPS (@14 VDC - single 100W speaker)
Standby Current	Less than 10mA
Output Power	105 WATTS RMS MAX. (15 VDC - single 100W speaker)
Siren Frequency	700Hz - 1500Hz (Mechanical 700Hz - 1600Hz; Two-Tone and Horn = 435 & 585Hz)
Tones / Cycle Rates	Horn Mechanical Wail Yelp Phaser Two-Tone
Cycle Rates	109 CPS 5 CPM 13 CPM 190 CPM 15 CPS 60 CPM
High Voltage Protection	16 - 18 VDC will cause siren output to cease, resumes at normal voltage
Short Circuit Current	50 AMPS (supply circuit must be capable of supplying this for 1 second)
Operating Temp.	-15° F to +140°F
Controls	Two 3-position rocker switches (Mechanical, Wail, Yelp, Manual, and Standby). Momentary rocker switch (Horn and Phaser momentary or toggle). Auxiliary input programmable for positive or negative activation. DIP switch option selector.
Connections	Removable 12-Pos Terminal Block with screw clamp terminals. (2) Power, (2) Speaker, Auxiliary input, (6) control switch inputs.
Light Control Section	
Controls	Two lighted rocker switches in control panel.
Current	20 AMPS per switch (Externally fused).
General	
Size	Control Head 4-1/2" Wide, 1-3/4" Deep, 2" High Amplifier 6" Wide, 4-1/4" Deep, 1-7/8" High
Weight	2 LBS

UNPACKING

Inspect contents for shipping damage. If found **alert carrier immediately**. Contact supplier immediately if any items are missing.

Qty	Item
1	Remote Amplifier
1	SC-1012-10CH Remote Panel Assembly
1	CP4688-12 12-Pin Terminal Block Plug
15	CP4062-K2523 Terminal, 3/16" Insulated
1	CP5163 Instruction Manual

INSTALLATION

Proper installation of the unit is essential for years of safe, reliable operation. Please read all instruction **before** installing the unit. Failure to follow these instructions can cause serious damage to the unit or vehicle and may void warranties.

SAFETY PRECAUTIONS

For the safety of the installer, vehicle operator, passengers and the community please observe the following safety precautions. **Failure to follow all safety precautions and instructions may result in property damage, injury or death.**

Qualifications - The installer must have a firm knowledge of basic electricity, vehicle electrical systems and emergency equipment.

Remote Panel Location - Locate the hand control for easy access by the vehicle operator, typically underneath the vehicle dashboard in a location away from the driver's or passenger's legs. DO NOT locate in air bag deployment area. Mounting hardware is not supplied.

Amplifier Mounting - Flanges are provided for mounting (hardware not supplied). Assure clearances before drilling in vehicle.

Wiring - Use wiring capable of handling the current required. Make sure all connections are tight. Route wiring to prevent wear, overheating and interference with air bag deployment. Install and check all wiring before connection to vehicle battery.

Testing - Test all siren functions after installation to assure proper operation. Test vehicle operation to assure no damage to vehicle.

Keep These Instructions - Keep these instructions in the vehicle or other safe place for future reference. Advise the vehicle operator of the location.

OPTION SWITCHES

An 8-position DIP switch on one side of the amplifier may be changed to select various options.

Adjusting Option Switches - use a small screwdriver to change switch settings.



The default setting is shown here. All switches are on.

SW-1 Auxiliary Input Polarity - The auxiliary input is normally activated with positive. Turn switch OFF for negative activation.

SW-2	SW-3	Auxiliary Tone in Standby
ON	ON	(Default) Produces Horn tone while activated.
OFF	ON	Manual control of Mechanical tone.
ON	OFF	Manual control of Wail tone.
OFF	OFF	Activates Horn Ring Cyclers 2 (HRC2) function.

SW-4 Two-Tone - Turn this switch OFF to replace Phaser with Two-Tone.

SW-5 Horn Enable - Turn this switch OFF to disable Horn tone. Horn replaced with Yelp.

SW-4 and 5 Tone Disable - All siren tones may be disabled except Manual, Wail and Yelp by turning OFF both switches. Mechanical will be replaced with Wail. Phaser and Horn will be replaced with Yelp.

SW-6 Short Manual - The Manual siren tone will normally fall and die out when released. Turn this switch OFF to have Manual stop immediately.

SW-7 Not Used

SW-8 Mechanical Fall - Turn this switch OFF for a quicker mechanical tone fall time.

HORN RING CYCLER 2 (HRC2) - Turn OFF DIP SW-2 and SW-3 to enable this feature. Also connect the auxiliary input to the horn ring or other switch. While the siren is in standby, tap the horn ring to bring the unit out of standby into Mechanical tone. Repeatedly tapping the horn ring will cycle through Mechanical, Wail, Yelp, and Phaser tones. Tapping the horn ring twice quickly will stop the siren tones and return the unit to standby. Pressing and holding the horn ring will produce Horn tone until released. Then the siren will return to its previous siren tone or standby.

ELECTRICAL CONNECTIONS

Electrical connections to the unit are made using terminal block plugs and screw terminals located on the amplifier. Labels on the unit identify each terminal function. Install the plug on the unit before wiring. If the unit needs service the plug can be easily removed without unwiring. The power supply of the unit must be capable of delivering peak currents up to 50 amps for adequate short circuit protection and reliable operation. The preferred source is directly at the vehicle battery. The amplifier is fused.

Attach leads by stripping 3/8", inserting into plug and clamp by tightening screw. Make sure the screw is tight and the wire can't be pulled out.

Failure to adequately tighten the screw can result in improper operation or burning the connector and wire.

Wire Size and Termination - The diagram shows the minimum wire size used for each connection, along with recommended lead color. If the wire is longer than 10 ft. use the next larger wire size. Use only high quality crimp connectors for installation on the vehicle.

Auxiliary Input Connection (Optional) - A momentary input typically connected to the horn ring of the vehicle or other switch. See OPERATION section for auxiliary input functions.

NOTE: Permanent disconnection of the vehicle horn is NOT recommended.

The auxiliary input may be activated with positive or negative voltage. See **Auxiliary Polarity** under OPTION SWITCHES section for proper activation polarity. Input current is 1 to 20 mA.

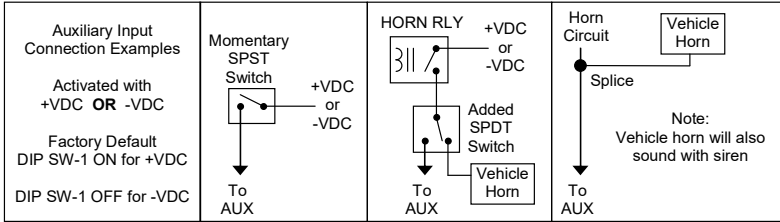

Note Top Orientation

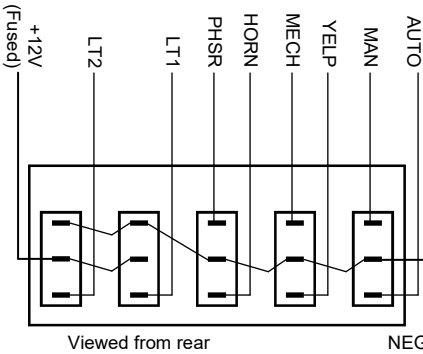
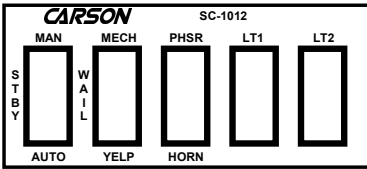

Viewed from rear

AUX #22G WHT

LT1 and LT2 Lighted Rocker Switch Circuit Note: External fusing required

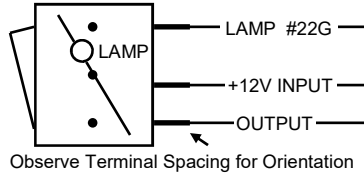

Recommended Wire Size	
Amps	Gauge
5 - 10	#16
10 - 15	#14
15 - 25	#12

Use next larger size if longer than 10 ft.

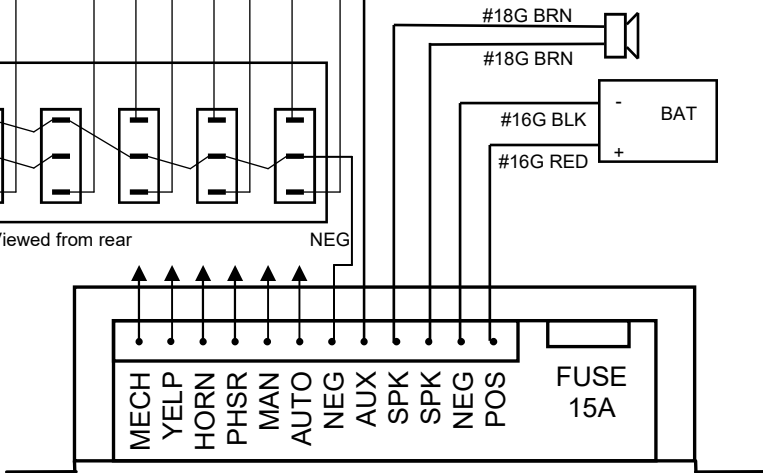

OPERATION

POWER ON/OFF

The unit is turned on with the siren controls.

SIREN CONTROLS

MAN - STBY - AUTO SELECTOR SWITCH

A 3-position rocker selector switch controls the primary operating mode of the siren.

Manual - Provides manual control of Mechanical and Wail tone rise and fall or momentary Yelp depending on the position of **Mech - Wail - Yelp** switch.

Auto - Keeps siren tone running (automatic rise and fall). Tone depends on the position of **Mech - Wail - Yelp** switch.

Standby - A silent mode that may be overridden anytime.

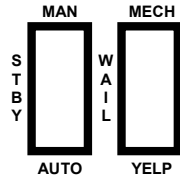

MECH - WAIL - YELP SELECTOR SWITCH

A 3-position rocker selector switch controls the primary siren tone.

Mech - A simulated mechanical siren tone. Tone may be changed or disabled. See OPTION SWITCHES section.

Wail - A slower changing tone used on highways.

Yelp - A rapidly changing tone used in congested areas.

PHASER SWITCH

A very rapid changing tone used at intersections and very highly congested areas. With selector switch in **Auto**, this tone override is toggled on and off by repeatedly pressing switch. With selector switch in **Standby**, this tone override is momentary as long as the switch is pressed. May be optionally replaced with **Two-Tone** or disabled. Two-Tone is two alternating frequencies like a European HI-LO. See OPTION SWITCHES section.



HORN SWITCH

Produces a simulated Air-Horn tone while pressed. Overrides all siren modes. Horn tone may be disabled. See OPTION SWITCHES section.

HORN

AUXILIARY INPUT FUNCTIONS

The switch or horn ring attached is intended to be momentary.

When the selector switch is in **Auto**, activating auxiliary will produce the Horn tone.

With selector switch in **Standby**, activating auxiliary will normally produce Horn tone. Different tones are available. See OPTION SWITCHES section.

Selector Position	Mech - Wail - Yelp Position	Phaser Switch	Horn Switch	Auxiliary Input (Horn Ring)
Standby	Silent	Mom. Phsr	Horn	Horn, M. Mech., M. Wail, or HRC2
Manual	M. Mech., M. Wail, or Yelp	Phsr Toggle	Horn	Horn
Auto	Mechanical, Wail, or Yelp	Phsr Toggle	Horn	Horn

Horn Ring Cyclcr 2 (HRC2) - this feature may also be added by turning on the HRC2 option. HRC2 is only available while the unit is in **Standby**. Tapping the attached horn ring or other switch, will bring the unit out of standby into Mechanical tone. Repeatedly tapping the horn ring will cycle through Mechanical, Wail, Yelp, and Phaser tones. Tapping the horn ring twice quickly will stop the siren tones and return the unit to standby. Pressing and holding the horn ring will produce Horn tone until released. Then the siren will return to its previous siren tone or standby.

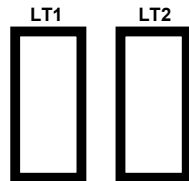

LIGHT CONTROLS

LT1 and LT2 LIGHTED ROCKER SWITCHES

When turned on the rocker switch will light up and activate the corresponding light output.

SERVICE

This unit is designed to provide years of reliable service under even the worst conditions. Many times there may appear to be a problem with the unit when the true problem is in the speaker, controlled devices, or improper installation. The following chart shows typical symptoms and possible causes.

A blown siren fuse doesn't necessarily mean that the unit is bad. If a speaker or speaker lead is shorted the fuse will blow before the unit is damaged. Disconnect the SPKR leads and replace the fuse. If the **amplifier makes noise** with Wail mode selected and Enable Input powered the amplifier is OK. Check the speaker or leads for possible shorting.

PROBLEMS

Symptom	Possible Cause	Check
No power or siren output	No power to enable input (org wire) Bad speaker Connector(s) loose Rear panel fuse blown Loose connection at power source	Is the amplifier making noise in Wail? Do you hear a "pop" when turned on? Is an external fuse or circuit breaker used? Are the negative leads connected to a good ground?
No siren tones	Bad Speaker High Voltage Protection	Is the amplifier making noise in Wail? Input voltage must be less than highest rated voltage.
Distorted siren sound	Speaker assembly loose Intermittent Aux Input connection Low vehicle voltage	Is the speaker bell or tip loose? Is the Aux Input used and wired properly? Input voltage must be greater than lowest rated voltage.
Intermittent siren tone	High Voltage Protection Connector loose Bad power connection Circuit breaker in supply connection	Is the vehicle voltage regulator working properly? Is the connector tight on the back of the unit? Is there a loose connection on a power lead? Is a circuit breaker used with at least a 50A rating?
Horn function stuck on or Manual stuck on	Horn or Manual switch stuck Aux Input improperly connected Aux Input Polarity Option set wrong	Does the horn or manual switch return when released? Is the Aux Input used and wired properly? Is the AUX_P option properly configured?
Wrong siren tone	Two-Tone option installed Tones disabled.	Is the T-T option selected? Check option switch settings.
Some siren tones not working	Tone disabled	Check option switch settings.
Light switches not working	Loose output connections Rear panel fuse blown	Do the Light Control switch indicators light? Is the corresponding fuse blown?

See www.carsonsirens.com for additional information
or contact our Service Department at:
E-mail service@carsonsirens.com or Phone (888) 577-6877

PARTS and ACCESSORIES

The following parts and accessories are available from Carson Manufacturing Company, Inc.:

Part	Description
CP4990-150	Fuse, 15 Amp Mini Automotive
CP4748-2	Switch, Red Rocker ON - OFF - ON (Mech - Wail - Yelp)
CP4751-2	Switch, Momentary Red Rocker Switch, (ON) - OFF - (ON) (Phsr - Horn)
CP4995-2	Switch, Red Rocker (ON) - OFF - ON (Man - Standby - Auto)
CP4993	Switch, Lighted Rocker for Light Control
Accessory	Description * - standard accessory supplied with unit
CP4688-12 *	Connector, 12-pin Terminal Block Plug
CP4062-K2523 *	Terminal, 3/16" insulated female Q.C.
SC-1012-10CH *	SC-1012 Remote Panel Assembly (includes rocker switches)
CP5163 *	Instruction Manual

See www.carsonsirens.com for additional information
or contact our Service Department at:
E-mail service@carsonsirens.com or Phone (888) 577-6877

RETURN

If you have any questions concerning this or any other Carson product, please contact our **Technical Service Department** at (888) 577-6877. Many issues can be handled over the phone. We can also be reached via e-mail at **service@carsonsirens.com**

If a product must be returned for any reason, please contact our Technical Service Department to obtain a Returned Merchandise Authorization number (RMA#) before you ship the product to Carson. Please write the RMA# clearly on the package near the mailing label. Be sure to provide a return address, contact and phone number, along with a brief description of the problem.

LIMITED WARRANTY

Carson Manufacturing Company, Inc. warrants this new product to be free from defects in material and workmanship, under normal use and service, for a period of five (5) years from the date of delivery to the first user-purchaser.

During this warranty period the obligation of Carson Manufacturing is limited to repairing or replacing, as Carson Manufacturing may elect, any part or parts of such product which after examination by Carson Manufacturing is determined to be defective in material and/or workmanship.

This warranty does not cover labor charges for removal or re-installation of the product. Fuses and lamps are not covered under this warranty.

This warranty does not extend to any unit that has been subjected to abuse, misuse, improper installation or which has not been adequately maintained, nor to units which have problems related to service or modification at any facility other than Carson Mfg.

THERE ARE NO OTHER WARRANTIES, EXPRESSED OR IMPLIED, INCLUDING BUT NOT LIMITED TO, ANY IMPLIED WARRANTIES OF MERCHANTABILITY OR FITNESS FOR A PARTICULAR PURPOSE. IN NO EVENT SHALL CARSON MANUFACTURING COMPANY, INC. BE LIABLE FOR ANY LOSS OF PROFITS OR ANY INDIRECT OR CONSEQUENTIAL DAMAGES ARISING OUT OF ANY SUCH DEFECT IN MATERIALS OR WORKMANSHIP.