

CARSON

Carson Manufacturing Co., Inc.
5451 North Rural Street
Indianapolis, IN 46220
Phone: (888) 577-6877 Fax: (317) 254-2667
www.carsonsirens.com

SA-500-27 SIREN AMPLIFIER WITH MECHANICAL TONE

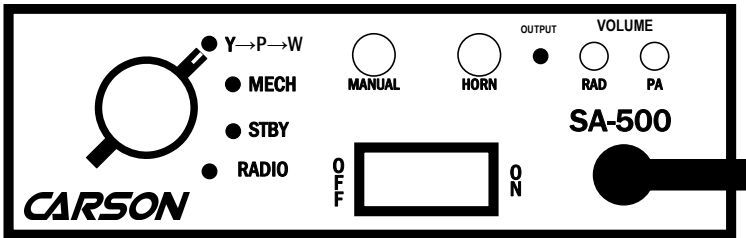

INSTALLATION AND OPERATING INSTRUCTIONS

Carson is a trademark of Carson Manufacturing Company, Inc.

WARNING Sound Hazard - Sound level from siren speaker (>120dB @ 10 feet) may cause hearing damage. Do not operate siren without adequate hearing protection for you and anyone in immediate vicinity. (Ref. OSHA 1910.95 for occupational noise exposure guidelines)

TABLE OF CONTENTS

GENERAL DESCRIPTION 3

SPECIFICATIONS 3

INSTALLATION 4

 SAFETY PRECAUTIONS 4

 UNPACKING 4

 OPTION SWITCHES 5

 MOUNTING 6

 ELECTRICAL CONNECTIONS 6

OPERATION 8

 GENERAL 8

 SELECTOR SWITCH 8

 MANUAL SWITCH 8

 HORN SWITCH 8

 MICROPHONE (PA Override) 9

 PA VOLUME CONTROL 9

 RADIO VOLUME CONTROL 9

 AUXILIARY INPUT 9

 CUTOUT INPUT 9

 HORN RING CYCLER 2 (HRC2) 9

SERVICE 10

 PROBLEMS 10

 PARTS and ACCESSORIES 11

 RETURN 12

 LIMITED WARRANTY 12

NOTICE

Due to continuous product improvements, we must reserve the right to change any specifications and information, contained in this manual at any time without notice.

Carson Manufacturing Co., Inc. makes no warranty of any kind with regard to this manual, including, but not limited to, the implied warranties of merchantability and fitness for a particular purpose.

Carson Manufacturing Co., Inc. shall not be liable for errors contained herein or for incidental or consequential damages in connection with the furnishing, performance, or use of this manual.

See www.carsonsirens.com for latest information.

GENERAL DESCRIPTION

The SA-500 Siren Amplifier with Mechanical Tone is a premium unit designed for single or dual 100W speaker use. A 4-position rotary selector switch controls the primary operating modes of Yelp -> Phaser -> Wail, Mechanical, Standby and Radio. Two-Tone may optionally replace Phaser. A Horn push-button switch provides Horn override in all modes except Radio. A Manual push-button switch provides Manual control of the output tone or toggling between tones depending on the selector switch setting. An independent rocker switch controls power. A permanently mounted Noise Canceling PA microphone overrides all modes except Radio. PA and Radio volume controls are provided on the front panel. An Auxiliary input is provided for connection to a positive or negative horn ring circuit or switch. A latching siren Cutout input is provided for connection to a door switch, etc. to stop siren tones when exiting the vehicle. An internal 8-Position DIP switch allows selection of various options. The front panel is backlit with LED's for night visibility. This compact unit utilizes short circuit, high voltage, and reverse polarity protection systems for maximum service life. Output indicator light on face for diagnostics.

SPECIFICATIONS

Input Voltage	9 - 16 VDC (negative ground)				
Input Current	8 AMPS (@14 VDC - single 100W speaker) 16 AMPS (@14 VDC - dual 100W speakers)				
Standby Current	Less than 150 ma				
Audio Frequency	200Hz - 10 kHz \pm 3db				
Audio Distortion	Less than 3% (@1 kHz - single 100W speaker)				
Audio Output	40 watts (@14 VDC - single 100W speaker)				
Audio Input	0.75V RMS MIN. 400 ohms \pm 10%				
Output Power	105 WATTS RMS MAX. (15 VDC - single 100W speaker) 180 WATTS RMS MAX. (15 VDC - dual 100W speakers)				
Siren Frequency	700Hz - 1500Hz (Mechanical 700Hz - 1600Hz, Two-Tone = 435 & 585Hz)				
Tones/Cycle Rates	Mech 6 CPM	Wail 13 CPM	Yelp 190 CPM	Phaser 15 CPS	Two-Tone 60 CPM
High Voltage Protection	16 - 18 VDC will cause siren output to cease, resume at normal				
Short Circuit Current	50 AMPS (supply circuit must be capable of supplying this)				
Operating Temp.	-15° F to +140°F				
Controls	4-position rotary mode switch (Y->P->W, Mechanical, Standby and Radio). Momentary push-button Horn switch. Momentary push-button Manual switch. Front panel PA and Radio volume controls. Auxiliary input connection programmable for positive or negative activation. Cutout input connection programmable for positive or negative latching operation. Internal 8-Position DIP switch option selector.				
Connections (10-Pin Conn)	(2) Positive, (2) Negative, (2) Speaker, (2) Radio, Cutout, Auxiliary				
Size	6-1/8" Wide, 5-7/8" Deep, 2-1/8" High				
Weight	4-1/2 LBS.				

INSTALLATION

Proper installation of the unit is essential for years of safe, reliable operation. Please read all instruction **before** installing the unit. Failure to follow these instructions can cause serious damage to the unit or vehicle and may void warranties.

SAFETY PRECAUTIONS

For the safety of the installer, vehicle operator, passengers and the community please observe the following safety precautions. **Failure to follow all safety precautions and instructions may result in property damage, injury or death.**

Qualifications - The installer must have a firm knowledge of basic electricity, vehicle electrical systems and emergency equipment.

	<p>WARNING Sound Hazard - Sound level from siren speaker (>120dBA @ 10 feet) may cause hearing damage. Do not operate siren without adequate hearing protection for you and anyone in immediate vicinity. (Ref. OSHA 1910.95 for occupational noise exposure guidelines)</p>
-----------------------------------------------------------------------------------	----------------------------------------------------------------------------------------------------------------------------------------------------------------------------------------------------------------------------------------------------------------------------------------

Mounting - Mount the unit for easy access by the vehicle operator. DO NOT mount in air bag deployment area. Assure clearances before drilling in vehicle. To prevent internal damage mounting bolts must not enter case more than 1/4".

Wiring - Use wiring capable of handling the current required. Make sure all connections are tight. Route wiring to prevent wear, overheating and interference with air bag deployment. Install and check all wiring before connection to vehicle battery.

Testing - Test all siren functions after installation to assure proper operation. Test vehicle operation to assure no damage to vehicle.

Keep These Instructions - Keep these instructions in the vehicle or other safe place for future reference. Advise the vehicle operator of the location.

UNPACKING

Inspect contents for shipping damage. If found **alert carrier immediately**.

Contact supplier immediately if any components are missing.

Contents of box should include the following items:

Qty	Item
1	Amplifier Unit with attached Microphone (SA-500-27 14)
1	Bracket, 'U' Dash Mount (CP3571)
1	Hardware Kit (ED1558) (Kit contains 2 Bolts, 1 10-P Term Block Plug, and 1 Mic Clip)
1	Instruction Manual (CP5015 This Manual)

OPTION SWITCHES

An internal 8-position DIP switch on the circuit board may be changed to select various options. The cover for the unit must be removed to access the DIP switch.

Accessing Option Switches - The cover is held in place by a snap-fastener on the back of the unit. Hold the unit with the front case flange on the edge of a hard surface and press hard on the back of the unit. The chassis will slide out the front of the cover.

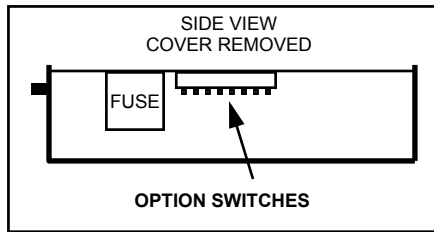

Adjusting Option Switches - the DIP Switch is located on the internal PCB assembly board toward the right side of the unit. Switch 1 is toward the back of the unit. Switch 'ON' position is toward the inside side of the unit.

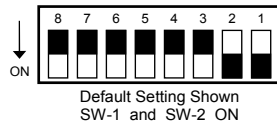

SW-1 Cutout Input Polarity - The cutout input is normally activated with positive. Turn this switch OFF for negative activation.

SW-2 Auxiliary Input Polarity - The auxiliary input is normally activated with positive. Turn this switch OFF for negative activation.

SW-3 Auxiliary Input Function - The auxiliary input normally activates the Horn function. Turn this switch ON to activate the Manual function. (Manual push-button)

SW-4 Two-Tone - Turn this switch ON to replace Phaser with Two-Tone.

SW-5 Manual Wail - The Manual push-button normally operates Manual Mechanical in Standby mode. Turn this switch ON to operate Manual Wail instead.

SW-6 Horn Ring Cycler 2 (HRC2) - Turn ON this switch to enable this feature. Also connect the auxiliary input to the horn ring or other switch. While the siren is in standby, tap the horn ring to bring the unit out of standby into Mechanical tone. Repeatedly tapping the horn ring will cycle through Mechanical, Wail, Yelp, and Phaser tones. Tapping the horn ring twice quickly will stop the siren tones and return the unit to standby. Pressing and holding the horn ring will produce Horn tone until released. Then the siren will return to its previous siren tone or standby.

SW-7 Wail Default - When the rotary selector switch is changed to Yelp -> Phaser -> Wail mode, the initial tone is Yelp. Turn this switch ON to make the initial tone Wail.

SW-8 Short Manual - The Manual Mechanical or Manual Wail tone normally falls and dies out when the Manual push-button is released. Turn this switch ON to have the tone stop immediately.

MOUNTING

The mounting bracket supplied can be installed above or below the unit. Choose a mounting location convenient to the operator and away from any air bag deployment areas. Inspect behind mounting area for clearance. Assure adequate ventilation to prevent overheating. Consider wire routing and access to connections, as well as microphone bracket placement. Install mounting bracket to vehicle using 1/4" hardware (not supplied).

If mounting in a rack or console, make sure that mounting bolts do not enter case more than 1/4".

ELECTRICAL CONNECTIONS

Electrical connections to the unit are made using a removable terminal block plug located on the back. A label on the unit identifies the terminal function. You should install the plug on the unit before wiring. If the unit needs service the plug can be easily removed without unwiring.

The power supply of the unit must be capable of delivering peak currents up to 50 amps for adequate short circuit protection and reliable operation. The preferred source is directly at the vehicle battery. The unit is internally fused.

Attach leads by stripping 3/8", inserting into plug and clamp by tightening screw. Make sure the screw is tight and the wire can't be pulled out. **Failure to adequately tighten the screw can result in improper operation or burning the connector and wire.**

Wire Size and Termination - The diagram shows the minimum wire size used for each connection, along with recommended lead color. If the wire is longer than 10 ft. use the next larger wire size. Use only high quality crimp connectors for installation on the vehicle.

Radio Input Connection (Optional) - Connect 1 lead to each terminal of the radio speaker or output connector. The input is isolated and polarity is not important. May need to set Radio Volume on front of unit.

Auxiliary Input Connection (Optional) - The Auxiliary Input allows activation by an external source of either the Horn or Manual function. Typically connected to the horn ring circuit of the vehicle or other momentary switch. May need to set activation polarity. See OPTION SWITCHES section for further details.



NOTE: Permanent disconnection of the vehicle horn is NOT recommended.

Cutout Input Connection (Optional) - The Cutout Input turns off any siren tone output when activated, and remains off until a face control is activated or changed. May need to set activation polarity. See OPTION SWITCHES section for further details.

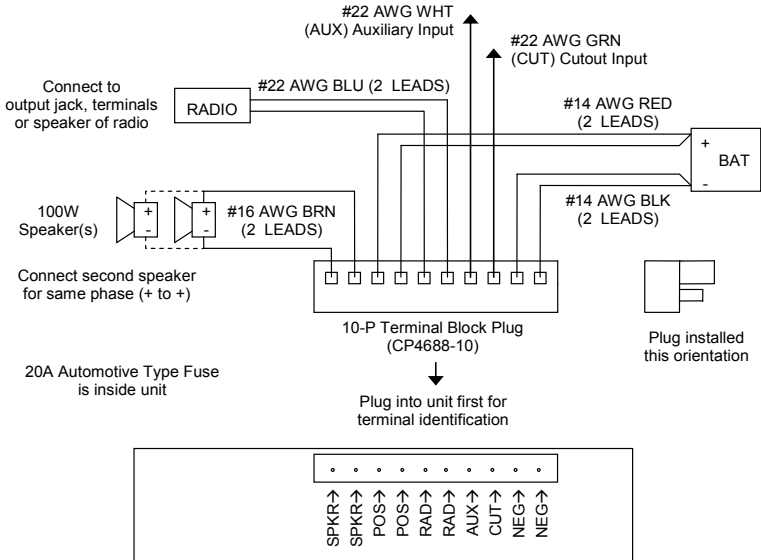
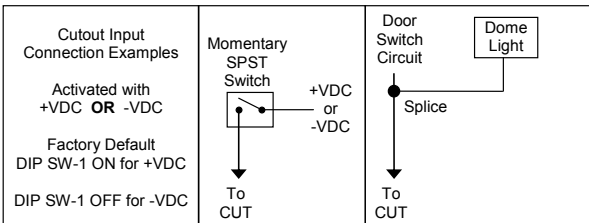
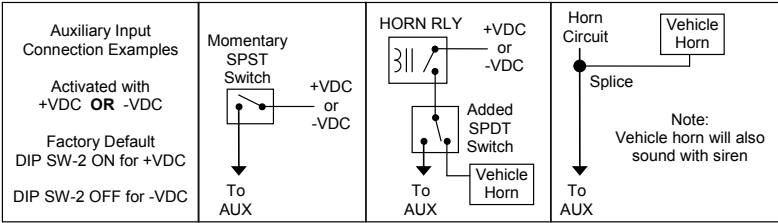
ELECTRICAL CONNECTIONS CONTINUED



OPERATION

WARNING   **Sound Hazard** - Sound level from siren speaker (>120dBA @ 10 feet) may cause hearing damage. Do not operate siren without adequate hearing protection for you and anyone in immediate vicinity. (Ref. OSHA 1910.95 for occupational noise exposure guidelines)

GENERAL

This unit is designed for easy operation under the stress associated with high-speed pursuit. Most siren functions are accessible with one simple motion without repetitive activation of switches or automatic timed switching that can interfere with desired operation.

SELECTOR SWITCH

The 4-position rotary selector switch controls the primary operating mode of the siren.

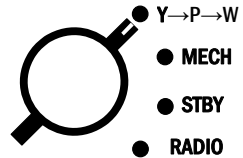

Radio - Also known as Radio Repeat, this function amplifies a radio speaker input for re-broadcast outside the vehicle. No siren tones or PA operation are available in this mode. The radio must be connected and radio volume adjusted for this mode to function.

Standby - A silent mode that may be overridden anytime with the Manual or Horn or PA operation.

Mech - A simulated mechanical siren tone used anytime.

Yelp -> Phaser -> Wail - This mode provides tones by pressing the Manual push-button to step through the tones. The initial tone is Yelp or optionally may be Wail.

See OPTION SWITCHES section.

Wail - A slower changing tone used on highways.

Yelp - A rapidly changing tone used in congested areas.

Phaser - A very rapidly changing tone used at intersections or in highly congested areas. May be optionally replaced with **Two-Tone** which is two alternating frequencies like a European HI-LO.

Rotary Switch	Operating Mode	Manual Switch	Horn Switch	Auxiliary Input
Y->P->W	Yelp	Yelp->Phaser->Wail Loop (Wail start option)	Horn	Horn Switch (Manual Switch option)
Mech	Mech	Manual Mechanical	Horn	Horn Switch (Manual Switch option)
Standby	Silent	Manual Mechanical (Manual Wail option)	Horn	Horn Switch (Manual Switch option) (HRC2 option)
Radio	Radio	Radio	Radio	Radio

See OPTION SWITCHES section.

MANUAL SWITCH

This momentary push-button switch provides manual tone control or stepping through tones depending on the selector switch position. Manual tone control is used to momentarily alert motorists or in low noise areas.



Manual Wail - Manual control of **Wail** tone rise and fall.

Manual Mech - Manual control of **Mech** tone rise and fall.

HORN SWITCH

This momentary push-button switch provides a simulated air-horn tone while pressed. This can be used to supplement the normal vehicle horn and is useful at intersections or in low noise areas. This tone overrides other siren tones.

MICROPHONE (PA Override)

The attached noise-canceling microphone is used for public address operation and overrides any siren tone when push-to-talk button on the side of the microphone is pressed.

PA VOLUME CONTROL

With the vehicle parked, set the PA volume to the maximum level with no feedback (squeal).

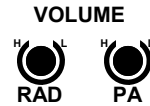
**RADIO VOLUME CONTROL**

With the vehicle parked and the radio volume itself set to a normal level, set the siren radio volume to the desired level.

AUXILIARY INPUT

During installation an auxiliary input may be connected to the horn ring or other switching device. It provides the same operation as pressing the Horn button or optionally the Manual button. See OPTION SWITCHES section for further details.

CUTOUT INPUT

During installation, a cutout input may be connected to a door switch. It turns off any siren tone when the door is opened. The siren tone will continue to be cut off even when the door is closed. Changing any switch on the face of the unit will restore normal function.

HORN RING CYCLER 2 (HRC2)

During installation, the auxiliary input must be connected and the HRC2 option selected. While the siren is in standby, tap the horn ring to bring the unit out of standby into Mechanical tone. Repeatedly tapping the horn ring will cycle through Mechanical, Wail, Yelp, and Phaser tones. Tapping the horn ring twice quickly will stop the siren tones and return the unit to standby. Pressing and holding the horn ring will produce Horn tone until released. Then the siren will return to its previous siren tone or standby. See OPTION SWITCHES section for further details.

SERVICE

This unit is designed to provide years of reliable service under even the worst conditions. Many times there may appear to be a problem with the unit when the true problem is in the speaker(s) or improper installation. The following chart shows typical symptoms and possible causes. A blown internal fuse doesn't necessarily mean that the unit is bad. If a speaker or speaker lead is shorted the internal fuse will blow before the unit is damaged. Disconnect the SPKR leads and replace the fuse. If the **OUTPUT** light comes on (dim lighting to see) with power on and Yelp selected it is OK. Check the speaker(s) or leads for possible shorting.

PROBLEMS

Symptom	Possible Cause	Check
No power or siren output	Power switch not turned on Bad speaker(s) Connector loose Internal fuse blown Loose connection at power source	Does backlighting come on? Do you hear a "pop" when turned on? Is the OUTPUT light on front panel coming on in Yelp? Is an external fuse or circuit breaker used? Are the negative leads connected to a good ground?
No siren tone - PA works	High Voltage Protection Mic button stuck Cutout activated Cutout Polarity Option set wrong	Input voltage must be less than highest rated voltage. Does mic button release properly? Does the siren work when Cutout input is disconnected? Is the option switch properly configured?
No PA	PA volume not set properly Selector in Radio position	Have you tried turning the PA volume control? PA is not available in the Radio position
Distorted siren sound	Speaker assembly loose Intermittent Aux Input connection Low vehicle voltage	Is the speaker bell or tip loose? Is the Auxiliary Input used and wired properly? Input voltage must be greater than lowest rated voltage.
Intermittent siren tone	High Voltage Protection Connector loose Bad power connection Mic button activation Circuit breaker in supply connection	Is the vehicle voltage regulator working properly? Is the connector tight on the back of the unit? Is there a loose connection on a power lead? Is something lying on the microphone? Is a circuit breaker used with at least a 50A rating?
Horn function or Manual function stuck on	Horn switch stuck Manual switch stuck Aux Input improperly connected Aux Input Polarity Option set wrong	Does the Horn switch return fully when released? Does the Manual switch return fully when released? Is the Aux Input used and wired properly? Is the option switch properly configured?
No Radio	Unit not connected to radio Radio volume too low	Is the radio connected properly to the unit? Can you here the radio in the vehicle? Have you tried turning the RAD volume control?
Wrong siren tone	Two-Tone option installed Aux Input set to wrong function Manual Wail option installed	Is the Two-Tone option switch selected? Is the Auxiliary Input option switch configured properly? Is the Manual Wail option switch selected?

See www.carsonsirens.com for additional information.

or contact our Service Department at:

E-mail service@carsonsirens.com or Phone (888) 577-6877

PARTS and ACCESSORIES

The following parts and accessories are available from Carson Manufacturing Company, Inc.:

Part	Description
CP5017	Button, Switch Cap Chrome (for push-button switch)
CP4684	Control, 1K Vertical w/ Knurled Shaft (PA and Radio Volume)
CP4680-1	Cover (not including chassis)
ATO/ATC 20A	Fuse, 20 Amp Automotive
CP4852	Knob, Selector Switch
CP5016	Label, SA-500-27 Front Panel
CP4750	Microphone, Noise Canceling w/Connector
SR-15-1	Microphone Strain Relief
CP4685	Switch, Momentary Push Button (Manual and Horn)
CP3962	Switch, Power Rocker
CP4683	Switch, Rotary 4-Pos. Selector
CP4119	Transistor, output (2 required)
Accessory	Description * - standard accessory supplied with unit
CP3633 *	Bracket, Microphone Clip with mounting screws
CP3571 *	Bracket, 'U' Dash Mount
CP3966 *	Bolts, 'U' Mounting Bracket (typically 2 ea required)
ED1756	Cable, 10-P Lead Assembly 8FT (made w/ CP4688-10 Conn)
CP4688-10 *	Connector, 10-P Terminal Block Plug
ED1558 *	Hardware Kit (2 Bolts, CP3633 Mic Clip, CP4688-10 Connector)
CP5015 *	Manual, SA-500-27 Instruction

See www.carsonsirens.com for additional information.
or contact our Service Department at:

E-mail service@carsonsirens.com or Phone (888) 577-6877

RETURN

If you have any questions concerning this or any other Carson product, please contact our **Technical Service Department** at (888) 577-6877. Many issues can be handled over the phone. We can also be reached via e-mail at **service@carsonsirens.com**

If a product must be returned for any reason, please contact our Technical Service Department to obtain a Returned Merchandise Authorization number (RMA#) before you ship the product to Carson. Please write the RMA# clearly on the package near the mailing label. Be sure to provide a return address, contact and phone number, along with a brief description of the problem.

LIMITED WARRANTY

Carson Manufacturing Company, Inc. warrants this new product to be free from defects in material and workmanship, under normal use and service, for a period of five (5) years from the date of delivery to the first user-purchaser.

During this warranty period the obligation of Carson Manufacturing is limited to repairing or replacing, as Carson Manufacturing may elect, any part or parts of such product which after examination by Carson Manufacturing is determined to be defective in material and/or workmanship.

This warranty does not cover labor charges for removal or re-installation of the product. Fuses and lamps are not covered under this warranty.

This warranty does not extend to any unit that has been subjected to abuse, misuse, improper installation or which has not been adequately maintained, nor to units which have problems related to service or modification at any facility other than the manufacturer.

THERE ARE NO OTHER WARRANTIES, EXPRESSED OR IMPLIED, INCLUDING BUT NOT LIMITED TO, ANY IMPLIED WARRANTIES OF MERCHANTABILITY OR FITNESS FOR A PARTICULAR PURPOSE. IN NO EVENT SHALL CARSON MANUFACTURING COMPANY, INC. BE LIABLE FOR ANY LOSS OF PROFITS OR ANY INDIRECT OR CONSEQUENTIAL DAMAGES ARISING OUT OF ANY SUCH DEFECT IN MATERIALS OR WORKMANSHIP.