

# CARSON

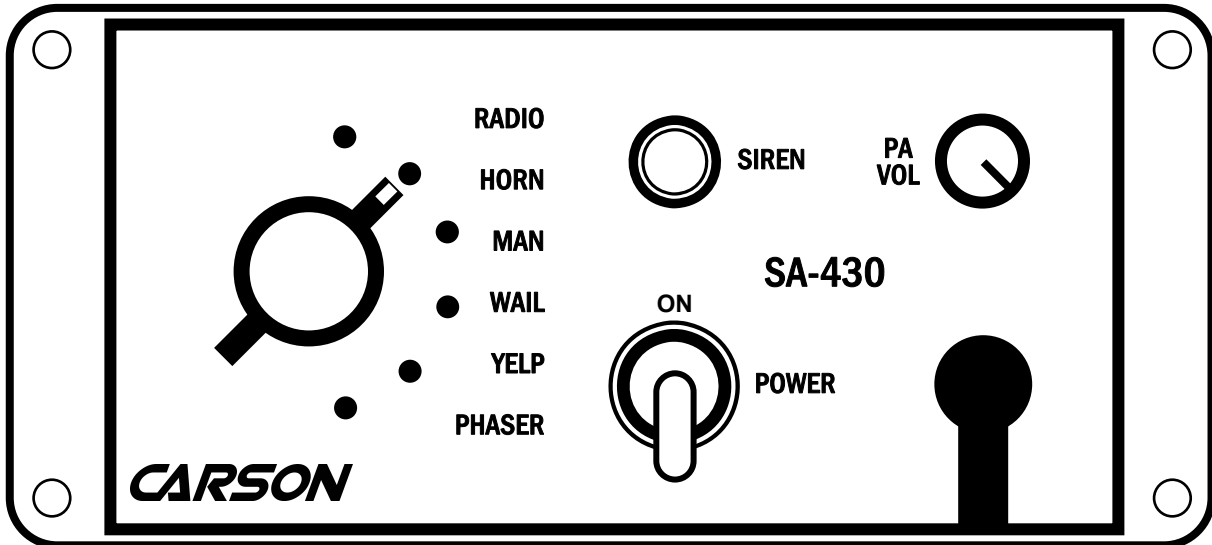

Carson Manufacturing Co., Inc.  
5451 North Rural Street  
Indianapolis, IN 46220  
Phone: (888) 577-6877 Fax: (317) 254-2667  
[www.carsonsirens.com](http://www.carsonsirens.com)

## SA-430-10 REMOTE SIREN AMPLIFIER



## INSTALLATION AND OPERATING INSTRUCTIONS

Carson is a trademark of Carson Manufacturing Company, Inc.

**WARNING**   **Sound Hazard** - Sound level from siren speaker (>120dBA @ 10 feet) may cause hearing damage. Do not operate siren without adequate hearing protection for you and anyone in immediate vicinity. (Ref. OSHA 1910.95 for occupational noise exposure guidelines)

## TABLE OF CONTENTS

TABLE OF CONTENTS .....	2
SPECIFICATIONS .....	3
NOTICE .....	3
GENERAL DESCRIPTION .....	4
INSTALLATION .....	5
SAFETY PRECAUTIONS.....	5
UNPACKING.....	5
OPTION SWITCHES.....	6
MOUNTING – Amplifier.....	7
MOUNTING – Control Head.....	7
ELECTRICAL CONNECTIONS - Amplifier.....	8
ELECTRICAL CONNECTIONS – Control Head.....	8
ELECTRICAL CONNECTIONS CONTINUED.....	9
OPERATION.....	10
GENERAL.....	10
SELECTOR SWITCH.....	10
SIREN SWITCH.....	10
MICROPHONE (PA Override).....	11
PA VOL.....	11
AUXILIARY INPUT.....	11
HORN RING CYCLER 2 (HRC2).....	11
RADIO VOLUME ADJUST.....	11
CUTOUT INPUT.....	11
SERVICE.....	12
PROBLEMS.....	12
PARTS and ACCESSORIES.....	13
RETURN.....	14
LIMITED WARRANTY.....	14
CONTROL HEAD INSTALLATION TEMPLATE .....	15

## SPECIFICATIONS

Input Voltage	11 - 16 VDC (negative ground)				
Input Current	8 AMPS (@14 VDC - single 100W speaker) 16 AMPS (@14 VDC - dual 100W speakers)				
Standby Current	Less than 250 mA				
Audio Frequency	200Hz - 10 kHz + 3db				
Audio Distortion	Less than 3% (@1 kHz - single 100W speaker)				
Audio Output	40 watts (@14 VDC - single 100W speaker)				
Audio Input	400 ohms + 10%				
Output Power	105 WATTS RMS MAX. (15 VDC - single 100W speaker) 180 WATTS RMS MAX. (15 VDC - dual 100W speakers)				
Siren Frequency	700Hz - 1500Hz (Two-Tone and Horn = 435Hz & 585Hz)				
Tones / Cycle Rates	Horn	Wail	Yelp	Phaser	Two-Tone
	109 CPS	13 CPM	190 CPM	15 CPS	60 CPM
High Voltage Protection	16 - 18 VDC will cause siren output to cease, resume at normal				
Short Circuit Current	50 AMPS (supply circuit must be capable of supplying this for 1 second)				
Operating Temperature	-15° F to +140° F				
Controls	6-position rotary selector switch (Radio, Horn, Manual, Wail, Yelp, and Phaser). Momentary push-button Siren switch. Front panel mounted PA volume control, Radio adjust on amplifier Auxiliary input for positive or negative connection. Cutout input connection programmable for positive or negative latching cutout operation. 8-position DIP switch option selector.				
Connections (10-Pin Conn)	(2) Positive, (2) Negative, (2) Speaker, (2) Radio, Control, Cutout				
Size	Control Head: 6-1/4" W x 2-7/8" H x 1" D Amplifier: 8" L x 6-3/4" W x 2-1/8" H				
Weight	5 LBS.				

## NOTICE

Due to continuous product improvements, we must reserve the right to change any specifications and information, contained in this manual at any time without notice.

Carson Manufacturing Co., Inc. makes no warranty of any kind with regard to this manual, including, but not limited to, the implied warranties of merchantability and fitness for a particular purpose.

Carson Manufacturing Co., Inc. shall not be liable for errors contained herein or for incidental or consequential damages in connection with the furnishing, performance, or use of this manual.

See [www.carsonsirens.com](http://www.carsonsirens.com) for latest information.

## GENERAL DESCRIPTION

The SA-430 Remote Siren Amplifier with is a premium unit designed for single or dual 100W speaker use. The control head is only 1 inch deep and can be installed in minimum clearance areas. Connection between the control head and amplifier is via a single lead wire with common ground.

A 6-position rotary selector switch controls the primary operating modes of Radio, Horn, Manual, Wail, Yelp, and Phaser. Two-Tone may optionally replace Phaser. A Siren push-button switch is provided for Manual control of the output tone or Horn or Yelp override, depending on the selector switch setting. An independent toggle switch controls power. A hole is provided in the amplifier to adjust Radio volume.

Depending upon the version, the microphone may or may not be directly mounted to the control head. Units with an "F" suffix have the microphone permanently mounted to the faceplate. Units with an "FX" suffix are provided with an extension harness and connectors for remote mounting of the microphone.

An auxiliary input is provided for connection to a positive or negative horn ring circuit or switch, performing the same function as the Siren push-button. A latching siren cutout input is provided for connection to a door switch, etc. to disable the siren when exiting the vehicle.

An 8-position DIP switch on the amplifier allows selection of various options: Two-Tone to replace Phaser, Phaser disable, Horn disable, and Horn Ring Cyclers 2 (HRC2), which allows cycling through Wail, Yelp, and Phaser by tapping the horn ring when the selector switch is in the Horn position. The front panel is backlit with LED's for night visibility.

This durable unit utilizes short circuit, high voltage, and reverse polarity protection systems for maximum service life over a wide temperature range.



## INSTALLATION

Proper installation of the unit is essential for years of safe, reliable operation. Please read all instruction **before** installing the unit. Failure to follow these instructions can cause serious damage to the unit or vehicle and may void warranties.

### SAFETY PRECAUTIONS

For the safety of the installer, vehicle operator, passengers and the community please observe the following safety precautions. **Failure to follow all safety precautions and instructions may result in property damage, injury or death.**

**Qualifications** - The installer must have a firm knowledge of basic electricity, vehicle electrical systems and emergency equipment.

**WARNING**   **Sound Hazard** - Sound level from siren speaker (>120dBA @ 10 feet) may cause hearing damage. Do not operate siren without adequate hearing protection for you and anyone in immediate vicinity. (Ref. OSHA 1910.95 for occupational noise exposure guidelines)

**Mounting** - Mount the control head for easy access by the vehicle operator. DO NOT mount in air bag deployment area. Assure clearances before drilling in vehicle.

**Wiring** - Use wiring capable of handling the current required. Make sure all connections are tight. Route wiring to prevent wear, overheating and interference with air bag deployment. Install and check all wiring before connection to vehicle battery.

**Testing** - Test all siren functions after installation to assure proper operation. Test vehicle operation to assure no damage to vehicle.

**Keep These Instructions** - Keep these instructions in the vehicle or other safe place for future reference. Advise the vehicle operator of the location.

### UNPACKING

Inspect contents for shipping damage. If found **alert carrier immediately.**

Contact supplier immediately if any components are missing.

Contents should include the following items:

#### Complete Unit

Qty	Item	-10F	-10FX
1	Amplifier, Remote (SA-430-10F or FX)	X	X
1	Bracket, Microphone Clip with mounting screws (CP3633)	X	X
1	Connector, 10-P Terminal Block Plug for Amplifier (CP4833-10)	X	X
1	Cable Assembly for Control Head, 5-P (CP3040)	X	X
1	Control Head with attached Microphone (SA-430-10CH)	X	
1	Control Head without Microphone (SA-430-10CHX)		X
1	Cable, Microphone Extension 18FT (CP3850)		X
1	Microphone, Detachable Noise Cancelling (ES00028-10)		X
1	Instruction Manual (CP5010 This Manual)	X	X

#### Amplifier Only

Qty	Item
1	Amplifier, Remote Only (SA-430-10AMP)
1	Connector, 10-P Terminal Block Plug for Amplifier (CP4833-10)
1	Instruction Manual (CP4854 This Manual)

## OPTION SWITCHES

An 8-position DIP switch on the remote amplifier may be changed to select various options.

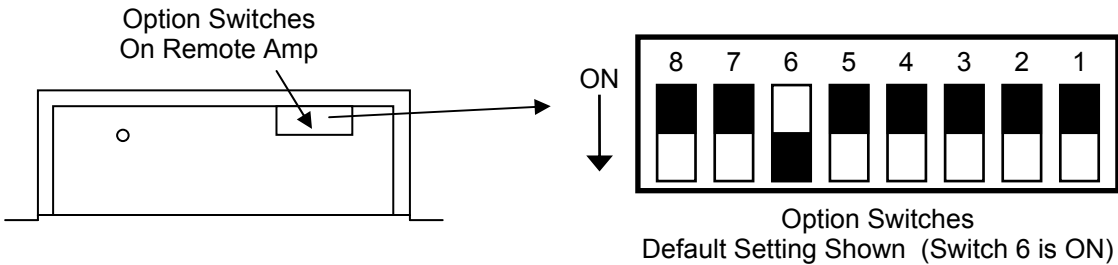

**SW-1 Two-Tone** - Turn this switch on to replace Phaser tone with Two-Tone.

**SW-1 and 2 Phaser Disable** - Turn on both switches to disable Phaser tone.

**SW-3 Horn Disable** - Turn this switch on to disable Horn tone.

**SW-4 Horn Ring Cyclor 2 (HRC2)** - Turn on this switch to enable this feature. Also connect the auxiliary input to the horn ring or other switch. While the siren is in standby, tap the horn ring to bring the unit out of standby into Wail tone. Repeatedly tapping the horn ring will cycle through Wail, Yelp, and Phaser tones. Tapping the horn ring twice quickly will stop the siren tones and return the unit to standby. Pressing and holding the horn ring will produce Horn tone until released. Then the siren will return to its previous siren tone or standby.

**NOTE:** Earlier units with S/N lower than 04190000 have a different version of **HRC**. In this case the siren tones cycle through Standby, Wail, Yelp, and Phaser. The tone is stopped by cycling to Standby.

**SW-5 - Not Used... Leave Off.**

**SW-6 and SW-7 Cutout Input Polarity** - The cutout input is normally disabled. Set the activation polarity as follows:

Positive Activation - SW-6 and SW-7 OFF.

Negative Activation - SW-6 and SW-7 ON.

Disabled - SW-6 ON and SW-7 OFF.

**SW-8 - Not Used... Leave Off.**

**MOUNTING – Amplifier**

Select a location for the amplifier in an area such as the driver compartment firewall, under a seat, etc. Mounting the amplifier in the engine compartment or in an area directly exposed to weather is not recommended. Assure adequate ventilation to prevent overheating. Allow clearance for wiring and radio adjustment. Inspect behind mounting area for clearance. Mark the location of the mounting holes to be drilled.

Drill 4 holes (up to 1/4" diameter) to mount the amplifier to the vehicle. Install the terminal block plug and make all electrical connections before final mounting (See ELECTRICAL CONNECTIONS – Amplifier). The plug is secured with the two locking screws. Then mount the amplifier to the vehicle using appropriate hardware (not supplied).

**MOUNTING – Control Head**

Select a mounting location in an area such as the dash or overhead console. Choose a mounting location convenient to the operator and away from any air bag deployment areas. Inspect behind mounting area for clearance. Allow 1 3/4" of depth to accommodate the control head and cable(s). Consider wire routing and access to connections, as well as microphone bracket placement.

Use template (back page) for marking hole and cutout locations. Connect control head cable to back of unit and route leads through cutout. Make all electrical connections (See ELECTRICAL CONNECTIONS – Control Head), and then use #6 screws for mounting the control head (not supplied).

**MOUNTING - Microphone Extension Harness ("FX" model only)**

Select a mounting location for the microphone connector, verifying adequate cable length. Allow 1-3/4" clearance behind connector to prevent sharp bends in the harness. Drill or punch a 5/8" diameter hole for mounting. Remove mounting nut and washer from connector. Insert the connector into the hole and secure it using a 3/4" socket to tighten the nut. Connect harness to the control head as shown prior to final installation of head.

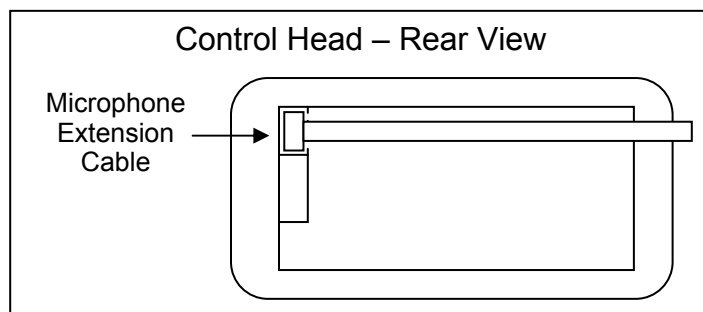

**ELECTRICAL CONNECTIONS - Amplifier**

Electrical connections to the amplifier are made using a terminal block plug located on the amplifier. A label on the unit identifies each terminal function. You should install the plug on the unit before wiring. If the unit needs service the plug can be easily removed without unwiring. The power supply of the unit must be capable of delivering peak currents up to 50 amps for adequate short circuit protection and reliable operation. The preferred source is directly at the vehicle battery. The amplifier is fused near connector.

Attach leads by stripping 3/8", inserting into connector and clamp by tightening screw. Make sure the screw is tight and the wire can't be pulled out.

**Failure to adequately tighten the screw can result in improper operation or burning the connector and wire.**

**Wire Size and Termination** - The diagram shows the minimum wire size used for each connection, along with recommended lead color. If the wire is longer than 10 ft. use the next larger wire size. The power lead pairs can be extended with single #10 AWG lead wire. Use only high quality crimp connectors for installation on the vehicle.

**Optional Radio Input Connection** - Connect one lead to each terminal of the radio speaker or output connector. The input is isolated and polarity is not important. May need to set RADIO VOLUME ADJUST on side of amplifier.

**Optional Cutout Input Connection** - The Cutout Input turns off any siren tone output when activated, and remains off until a control is activated or changed. May need to set polarity. See OPTION SWITCHES section for programming details.

**ELECTRICAL CONNECTIONS – Control Head**

All control head leads can be extended with #22 AWG or larger lead wire.

**Black: Negative** - Connect to same ground or negative supply as amplifier.

**Red: Positive** - May be connected to +VDC supply. It is recommended that the lead be connected to the accessory output of the fuse block. This provides additional protection of a fused input to the control head.

**Yellow: Lights** - This lead may be connected to the dash lights or to the red power lead. Connecting to the dash lights will turn on the panel lights whenever the dash lights are on. When connected to the red lead, make sure that the ignition switch controls the power to that connection. This prevents the panel lights from being continuously on.

**White: Control** - Connect white leads from amplifier and control head. Route this lead away from the transmitter antenna lead to prevent R.F. interference being fed to the siren amplifier.

**Green: Auxiliary Input** - Used for Siren control. Performs same function as Siren button. Connect to a normally open switch or to horn ring circuit. Circuit may connect to either positive or negative. When connected to horn ring circuit, use a SPDT switch to connect horn ring to either vehicle horn or to manual control circuit.

NOTE: Permanent disconnection of the vehicle horn is NOT recommended.

NOTE: Be sure to cut lead short if not used and insulate with electrical tape.



**ELECTRICAL CONNECTIONS CONTINUED**

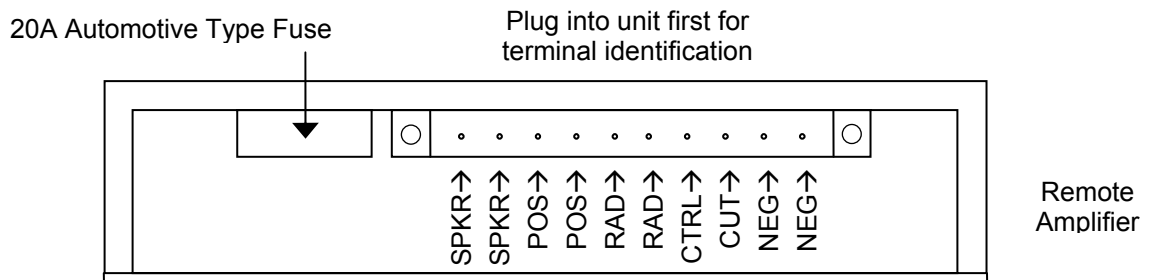
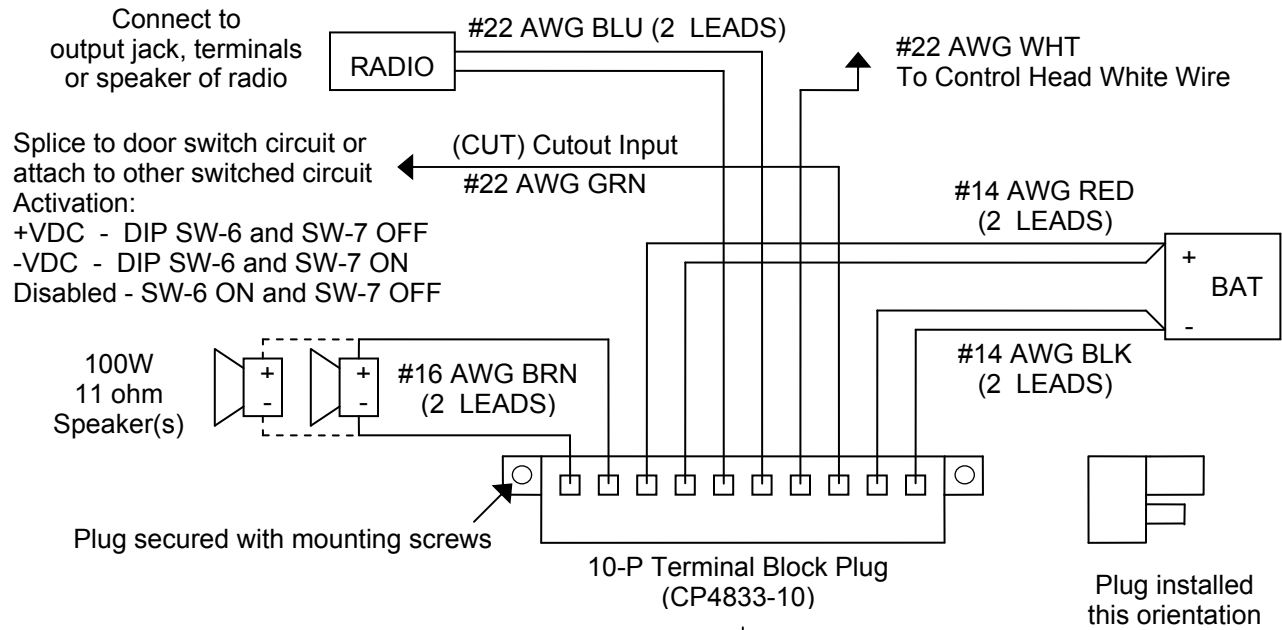
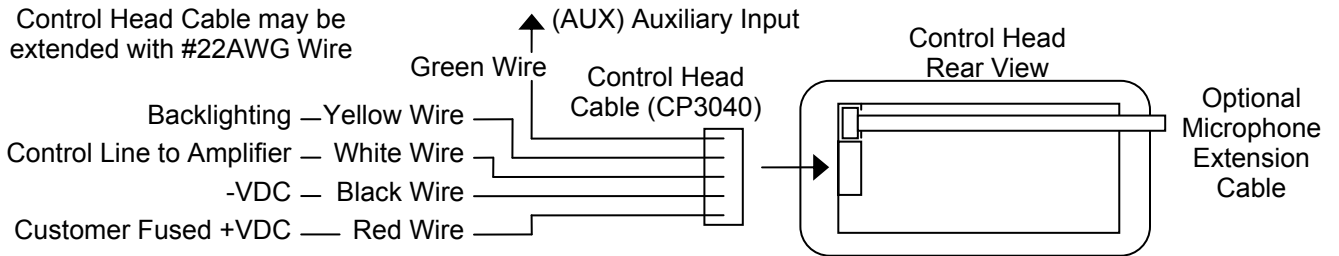
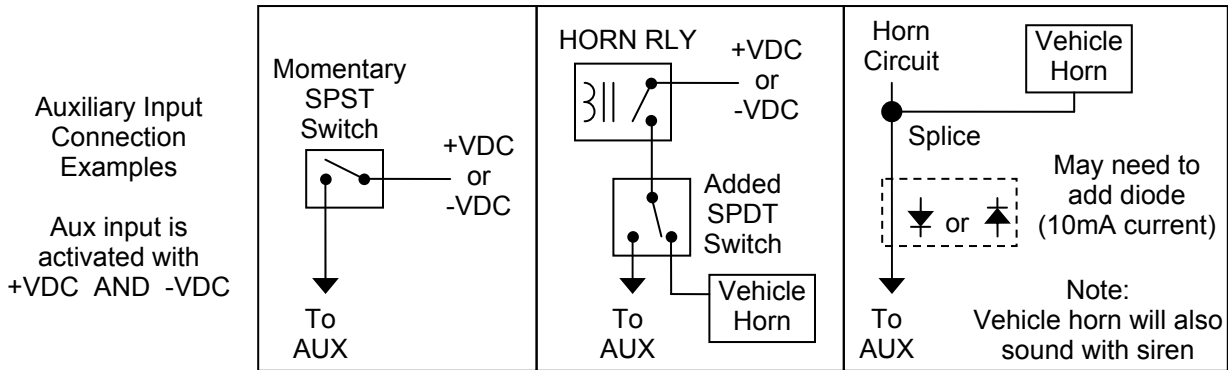

## OPERATION

**WARNING** **Sound Hazard** - Sound level from siren speaker (>120dBA @ 10 feet) may cause hearing damage. Do not operate siren without adequate hearing protection for you and anyone in immediate vicinity. (Ref. OSHA 1910.95 for occupational noise exposure guidelines)



### GENERAL

This unit is designed for easy operation under the stress associated with high-speed pursuit. Most siren functions are accessible with one simple motion without repetitive activation of switches or automatic timed switching that can interfere with desired operation.

### SELECTOR SWITCH

The 6-position rotary selector switch controls the primary operating mode of the siren.

**Radio** - Also known as Radio Repeat, this function amplifies a radio speaker input for re-broadcast outside the vehicle. The radio must be connected and RADIO VOLUME ADJUSTed for this mode to function.

**Horn** - A standby (silent) mode that may be overridden anytime with the Siren push-button to produce a simulated Air-horn tone. Horn tone may be disabled. See OPTION SWITCHES section.

See OPTION SWITCHES section.

**Manual** - The siren tone rise and fall is manually controlled with Siren push-button.

**Wail** - A slower changing tone used on highways.

**Yelp** - A rapidly changing tone used in congested areas.

**Phaser** - A very rapidly changing tone used at intersections or in highly congested areas. May be disabled or optionally replaced with **Two-Tone** which is two alternating frequencies like a European HI-LO. See OPTION SWITCHES section.

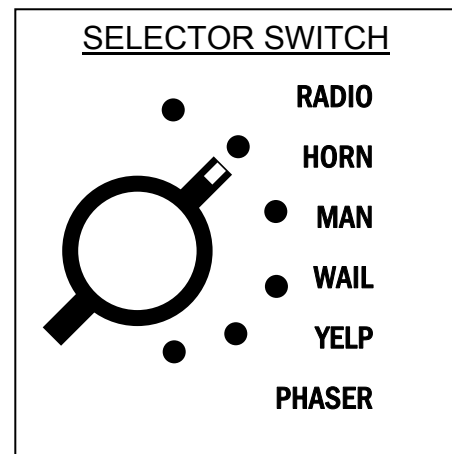

### SIREN SWITCH

This momentary push-button switch provides Manual tone control and various tone overrides depending on the Selector switch setting. It can optionally control Horn Ring Cyclor 2 operation in the Horn position if the **HRC2** option is selected. See OPTION SWITCHES section.



Selector Switch	Operating Mode	Activate Siren push-button or Auxiliary Input Override
Radio	Radio	No Change
Horn	Silent	Horn (Default) or HRC2 (See OPTION SWITCHES section)
Manual	Silent	Manual siren tone
Wail	Wail	Toggle between Wail and Yelp
Yelp	Yelp	Horn
Phaser	Phaser	Horn

### MICROPHONE (PA Override)

The noise-canceling microphone is used for public address operation and overrides any function when the push-to-talk button on the side of the microphone is pressed.

### PA VOL

This control adjusts the PA volume. With the vehicle parked, set the PA volume to the maximum level with no feedback (squeal).



### AUXILIARY INPUT

During installation an auxiliary input may be connected to the horn ring or other switching device. It provides the same operation as pressing the Siren push-button.

### HORN RING CYCLER 2 (HRC2)

During installation, the auxiliary input must be connected and the HRC2 option selected. While the siren is in standby, tap the horn ring to bring the unit out of standby into Wail tone.

Repeatedly tapping the horn ring will cycle through Wail, Yelp, and Phaser tones. Tapping the horn ring twice quickly will stop the siren tones and return the unit to standby. Pressing and holding the horn ring will produce Horn tone until released. Then the siren will return to its previous siren tone or standby. See OPTION SWITCHES section for further details.

**NOTE:** Earlier units with S/N lower than 04190000 have a different version of **HRC**. In this case the siren tones cycle through Standby, Wail, Yelp, and Phaser. The tone is stopped by cycling to Standby.

### RADIO VOLUME ADJUST

The radio repeat volume level is set using an adjustment on the side of the amplifier. Set the Selector Switch to the Radio position and turn on the power. With the radio volume itself set to a normal level, set the siren radio volume adjust control to the desired level.

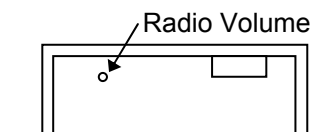

### CUTOUT INPUT

During installation, a cutout input may be connected to a door switch. It turns off any siren tone when the door is opened. The siren tone will continue to be cut off even when the door is closed. Changing any switch or input will restore normal function.

## SERVICE

This unit is designed to provide years of reliable service under even the worst conditions. Many times there may appear to be a problem with the unit when the true problem is in the speaker(s) or improper installation. The following chart shows typical symptoms and possible causes.

A blown amplifier fuse doesn't necessarily mean that the unit is bad. If a speaker or speaker lead is shorted this fuse will blow before the unit is damaged. Disconnect the SPKR leads and replace the fuse. If the siren emits a sound when in the Yelp position it is OK. Check the speaker(s) or leads for possible shorting.

## PROBLEMS

Symptom	Possible Cause	Check
No power or siren output	Power switch not turned on Bad speaker(s) Connector loose Amplifier/control head fuse blown Loose connection at power source	Does backlighting and power indicator on control head come on? Do you hear a "pop" when turned on? Is an external fuse or circuit breaker used? Are the negative leads connected to a good ground?
No siren tone - PA works	High Voltage Protection Mic button stuck Cutout activated Cutout polarity option set wrong	Input voltage must be less than highest rated voltage. Does mic button release properly? Does siren work when Cutout Input is disconnected? Are the corresponding option switches set correctly?
No PA	PA volume not set properly	Have you tried turning the PA volume control?
Distorted siren sound	Speaker assembly loose Intermittent Aux Input connection Low vehicle voltage	Is the speaker bell or tip loose? Is the Aux Input used and wired properly? Input voltage must be greater than lowest rated voltage.
Intermittent siren tone	High Voltage Protection Connector loose Bad power connection Mic button activation Circuit breaker in supply connection	Is the vehicle voltage regulator working properly? Are connections tight on the amplifier/control head? Is there a loose connection on a power lead? Is something lying on the microphone? Is a circuit breaker used with at least a 50A rating?
Horn function Or Manual stuck on	Siren switch stuck Aux Input improperly connected	Does the Siren switch return fully when released? Is the Aux Input used and wired properly?
No Radio	Unit not connected to radio Radio volume too low	Is the radio connected properly to the unit? Can you here the radio in the vehicle? Have you tried turning the radio volume control?
Wrong siren tone	Two-Tone option installed Ground system noise	Is the Two-Tone option selected? Are Control head and amplifier connected to good ground?
Phaser not working	Phaser disabled	Is the Phaser Disable option selected?
Horn not working	Horn disabled	Is the Horn Disable option selected?

See [www.carsonsirens.com](http://www.carsonsirens.com) for additional information.

or contact our Service Department at:

E-mail [service@carsonsirens.com](mailto:service@carsonsirens.com) or Phone (888) 577-6877.

**PARTS and ACCESSORIES**

The following parts and accessories are available from Carson Manufacturing Company, Inc.:

<b>Part</b>	<b>Description</b>
CP5018	Button, Switch Cap Red (for Siren pushbutton)
CP4732	Control, 1K Vertical Trimmer (Amplifier)
CP4834	Control, 1K Ohm Vertical Mini-Pot (Control Head PA)
CP4812-1	Cover, Amplifier (Does not include Chassis)
CP3880	Cover, Control Head back
ATO/ATC 20A	Fuse, 20 Amp Automotive
CP4852	Knob, Selector Switch Knob
CP4853	Knob, PA Volume Control
CP4840	Label, SA-430-10 Front Panel
CP4750	Microphone, Noise Canceling w/Connector
SR-15-1	Microphone Strain Relief
CP5014	Nut, 1/4-40 Dress (for Siren pushbutton)
8121D2V40	Switch, Momentary Push Button, Vertical (Siren pushbutton)
7101-T-C-Q	Switch, Power Toggle
CP3599	Switch, Rotary 6-Pos. Selector, Vertical
CP4119	Transistor, Output (2 required)
<b>Accessory</b>	<b>Description</b> * - standard accessory supplied with unit F or FX model
CP4872	Bracket, Control Head Console Mounting
CP3633 *	Bracket, Microphone Clip with mounting Screws
CP3040 *	Cable, 5-P Control Head Lead Assembly
ED1757	Cable, 10-P Amplifier Lead Assembly 8FT (made w/ CP4833-10 Conn)
CP3850 *	Cable, Microphone Extension 18FT for FX model
CP4833-10 *	Connector, 10-P Terminal Block Plug w/Locking Screws (Amplifier)
ES00028-10 *	Microphone, Detachable Noise Canceling for FX model
SA-430-10AMP	SA-430-10 Remote Amplifier (includes CP4833-10 Connector)
SA-430-10CH *	SA-430-10 Control Head with attached Microphone for F model
SA-430-10CHX *	SA-430-10 Control Head without Microphone for FX model
CP4854 *	Manual, SA-430-10 Instruction

See [www.carsonsirens.com](http://www.carsonsirens.com) for additional information.  
or contact our Service Department at:  
E-mail [service@carsonsirens.com](mailto:service@carsonsirens.com) or Phone (888) 577-6877.

**RETURN**

If you have any questions concerning this or any other Carson product, please contact our **Technical Service Department** at (888) 577-6877. Many issues can be handled over the phone. We can also be reached via e-mail at [service@carsonsirens.com](mailto:service@carsonsirens.com)

If a product must be returned for any reason, please contact our Technical Service Department to obtain a Returned Merchandise Authorization number (RMA#) before you ship the product to Carson. Please write the RMA# clearly on the package near the mailing label. Be sure to provide a return address, contact and phone number, along with a brief description of the problem.

**LIMITED WARRANTY**

*Carson Manufacturing Company, Inc. warrants this new product to be free from defects in material and workmanship, under normal use and service, for a period of five (5) years from the date of delivery to the first user-purchaser.*

*During this warranty period the obligation of Carson Manufacturing is limited to repairing or replacing, as Carson Manufacturing may elect, any part or parts of such product which after examination by Carson Manufacturing is determined to be defective in material and/or workmanship.*

*This warranty does not cover labor charges for removal or re-installation of the product. Fuses and lamps are not covered under this warranty.*

*This warranty does not extend to any unit that has been subjected to abuse, misuse, improper installation or which has not been adequately maintained, nor to units which have problems related to service or modification at any facility other than the manufacturer.*

**THERE ARE NO OTHER WARRANTIES, EXPRESSED OR IMPLIED, INCLUDING BUT NOT LIMITED TO, ANY IMPLIED WARRANTIES OF MERCHANTABILITY OR FITNESS FOR A PARTICULAR PURPOSE. IN NO EVENT SHALL CARSON MANUFACTURING COMPANY, INC. BE LIABLE FOR ANY LOSS OF PROFITS OR ANY INDIRECT OR CONSEQUENTIAL DAMAGES ARISING OUT OF ANY SUCH DEFECT IN MATERIALS OR WORKMANSHIP.**

### CONTROL HEAD INSTALLATION TEMPLATE

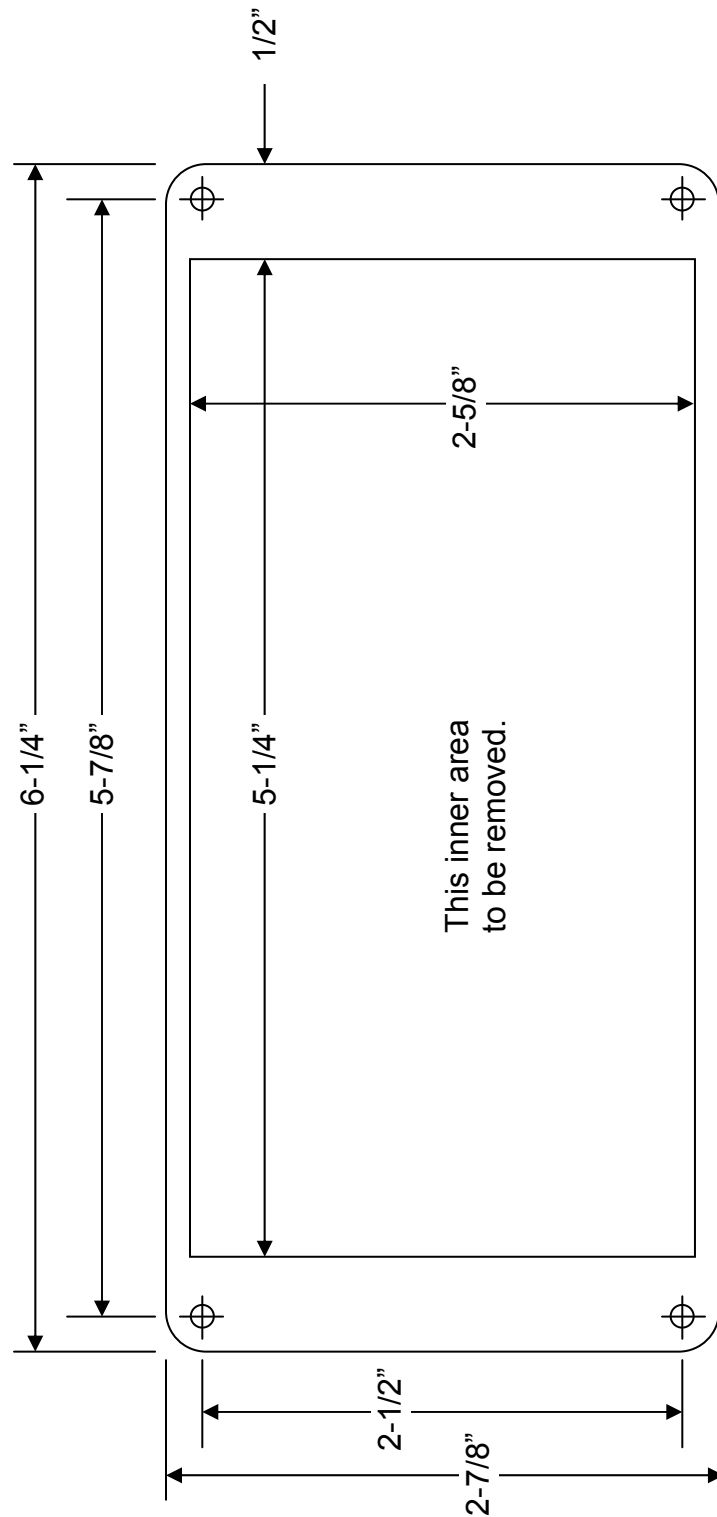

**CAUTION:** Please note that top and bottom edges only provide 1/8" overlap. Cut carefully.

BLANK PAGE